

## IP-Mole IP 80 Z

## Racheta de subtraversare IP 80 Z

- 2 - carcasa
- 3 - piston
- 4 - supapa de control
- 5 - set inele supapa din cauciuc (4 bucati)
- 6 - suport exterior manson
- 7 - amortizor
- 8 - supapa cu clapeta

- 10 - arc
- 11 - suport arc
- 12 - siguranta tip Seger
- 13 - inel distantier
- 14 - suport posterior filetat
- 15 - piulita / niplu fixare furtun

- 16 - furtun cu cuplaje
- 20 - cap taietor
- 101 - varf de spargere
- 402 - manson de control

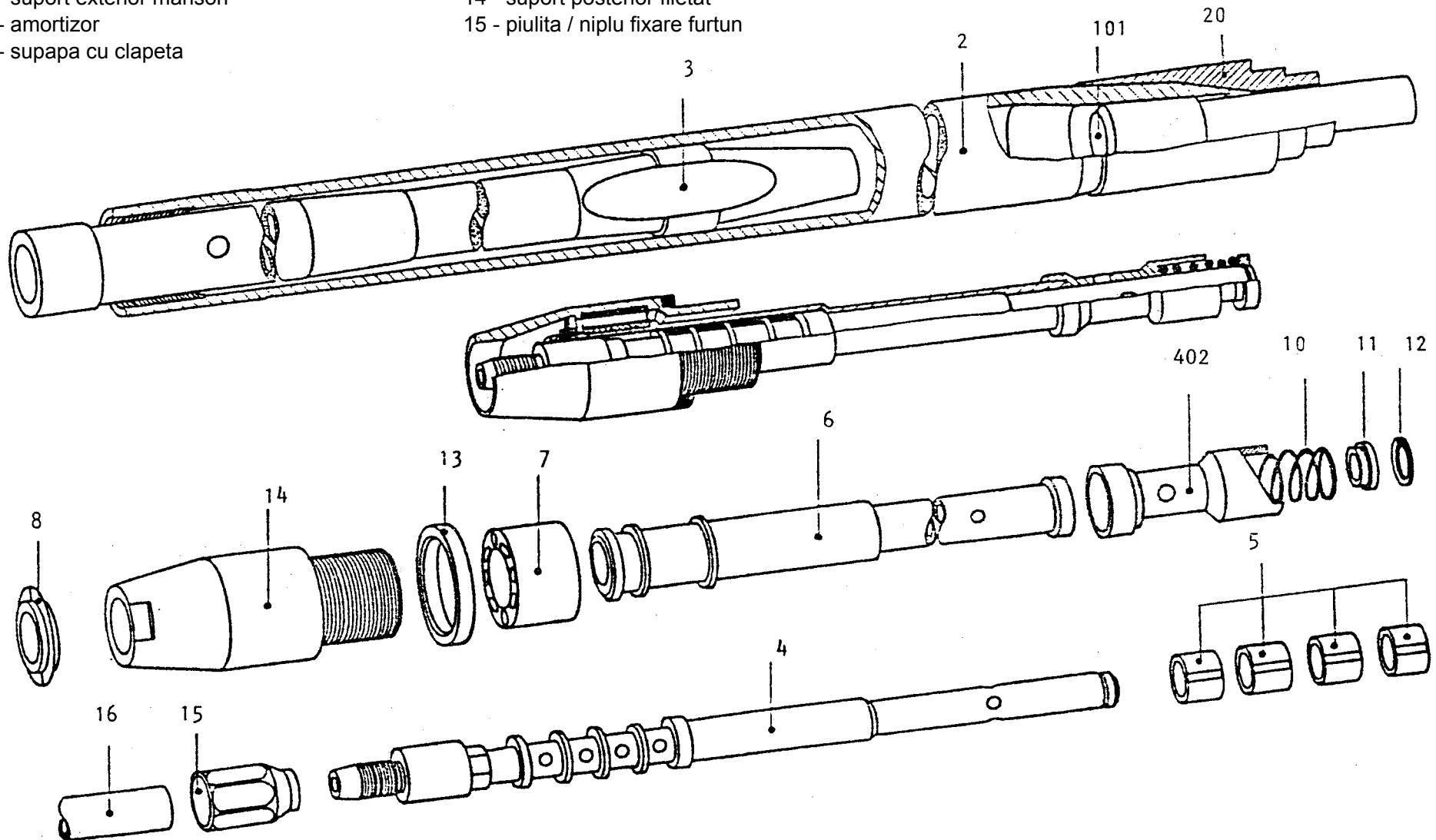

### Essig IP-Mole IP 80 Z

Made in Germany by Fa. H. Jürgen Essig, Industrielle Anlagen GmbH & Co. KG • Gänsekamp 35 • 32457 Porta-Westfalica • Fon - 49 - 5 71 - 7 20 90

Distributed in Romania by GEPETTO CONSULT Brasov, Tel. 0730 188 888, Fax 0268 / 477983, E-mail: info@gp2.ro, web www.gepetto-consult.ro