

# Precision Tooling

CHAIN SAW ACCESSORIES

BRUSHCUTTERS ACCESSORIES

CHAIN SAW SPARE PARTS

FORESTRY  
AND GARDENING  
ACCESSORIES

PRODUCT CATALOGUE 2008-2009



## CHAIN SAW ACCESSORIES



page 2 - 21

## BRUSHCUTTERS ACCESSORIES



page 22 - 61

## CHAIN SAW SPARE PARTS



page 62 - 83



PrecisionTooling® is a line of non genuine spare parts suitable to professional chain saws, chain saw accessories and brush-cutter accessories.

The PrecisionTooling® name and trade mark is well known all over the world but in particular is very well established in the tropical areas where the professional chain saws have an heavy and daily use and consequently the demand of spare parts is very high: PrecisionTooling® has made its name as reference for the top quality non genuine spare parts.

Thousands and thousands of cylinders, pistons, crankshafts, air filters, electrical parts etc. are sold every year under the PrecisionTooling® name and in many years of marketing the PrecisionTooling® products have reached the most remotes areas inside the tropical forests of Asia, Africa and South America.

PrecisionTooling® started it's activity as private company in the 80's and in 1998 has become part of Tecomec® S.p.a., adding an important and strategic role in the chain saw spare parts and accessories business.

The product descriptions written in this catalogue do not represent guaranteed characteristics. We reserve the right to make technical modifications at any time without prior notification.



FORESTRY

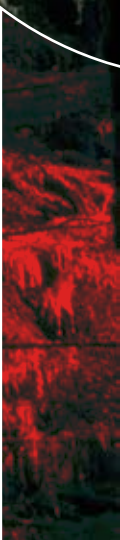







Speed sharp Star.....	4
Speed sharp .....	5
Speed sharp automatic.....	6
Speed master .....	7
Bar mini grinder .....	8
Grinding wheels.....	9
Special vise .....	10
Dressing stone and Template .....	10
Rivet master .....	11
Rivet spinner auto.....	12
Pro filing guide.....	13
Filing vise.....	13
File handles .....	14
File holders .....	14
File holders .....	14
Flat file holders .....	15
Dept gauge jointers .....	15
Bar groove cleaner .....	15
Steel chain breaker.....	16
Slotted anvil .....	16
Punches.....	16
Steel rivet spinner.....	17
Take up handles .....	17
Spinner inserts.....	17
Pocket chain breaker.....	18
Filing vise.....	18
Grease gun.....	18
Grease gun.....	18
Bar guard standard.....	19
Wedges.....	19
Lawnmower blade balancer.....	19
Universal nylon piston stop.....	20
Nylon piston stop .....	20
Metal piston stop .....	20
Piston ring clamp set .....	21
Pressure gauge .....	21
Pressure gauge kit.....	21

## Packaging & Shipment

### Type of packaging

	Carton box
	Plastic clamshell / Blister
	Nylon bag

### Type of shipment and minimum q.ty per order

	Carton master shipper
---	-----------------------

## Speed sharp Star

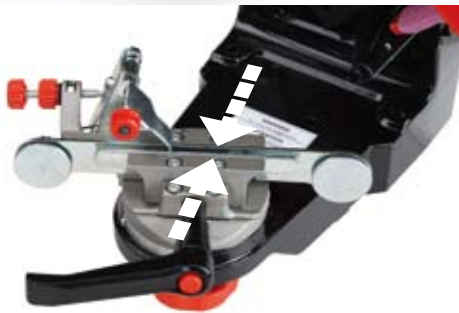

### Self-centering chain vice

Equal grind angles without adjustment. The new self-centering vice ensures the correct & perfect relation between the chain axis and the vice rotation axis for all types of chain from **1/4" pitch to 3/4" pitch**. When actioning the vice adjustment knob, both vice jaws close on the chain. This ensures the chain is ideally positioned at all times for optimum grind geometry & equal grind angles.

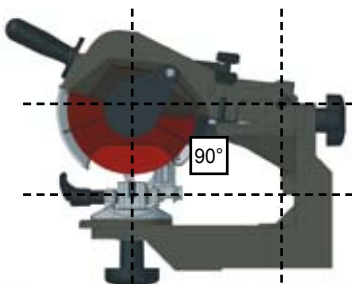

### grinding head pivot axis

The pivot axis of the head and vice have been repositioned for a better geometric solution ensuring a right/left hand grind equality.

### DESCRIPTION

### P/N

230 V~ 50 Hz	CE	TUV	230 V	CHAIN GRINDER	<b>11509002</b>
120 V~ 60 Hz	UL	LISTED GRINDING MACHINE 410A	120 V	CHAIN GRINDER	<b>11509001</b>

► New concept bench chain grinder designed for perfect matching the original chain cutting angles.

#### EASY AND RELIABLE:

- Self-centering chain vise: Equal and consistent grinding angles without additional adjustments
  - Clear and evident setting steps since based on saw chain geometry
  - Correct position of grinder's head pivot axis on the chain on all positions
- Most reliable sharpening of all sizes of saw chains: from **1/4" to 3/4" pitch**.

**BEST GRIND AND CHAIN PERFORMANCE ENSURED!**

#### STANDARD PACKING

1 PC. PER BOX



#### Box packaging



### PROVIDED WITH FOLLOWING ITEMS

### P/N



GRINDING WHEELS 1/4" - 3/8" - .325" chains **1005231**  
for depth gauge **1005232**  
.325" - .404" - 3/8" chains **1005233**



TEMPLATE **1112001**





DRESSING STONE **1005040**



WRENCH HEX. 4 **3052004**  
HEX. 5 **3052005**

## Speed sharp



DESCRIPTION		P/N
230 V~ 50 Hz	 	230 V CHAIN GRINDER <b>1150900</b>
		230 V CHAIN GRINDER - 3/4" <b>1150901</b>
120 V~ 60 Hz		120 V CHAIN GRINDER <b>1150910</b>
		120 V CHAIN GRINDER - 3/4" <b>1150912</b>

► Electrical chain grinder for professional use. Powerful, quick and precise, the machine is suitable for all chain pitches and types. The machine is supplied assembled and comes complete with a built-in lamp.

STANDARD PACKING

1 PC. PER BOX



### PROVIDED WITH FOLLOWING ITEMS

P/N



GRINDING WHEELS

1/4" - 3/8" - .325" chains  
for depth gauge  
.325" - .404" - 3/8" chains

**1005231**  
**1005232**  
**1005233**



TEMPLATE

**1112001**



DRESSING STONE

**1005040**





WRENCH

HEX. 4  
HEX. 5

**3052004**  
**3052005**

## Speed sharp automatic



DESCRIPTION		P/N
230 V~ 50 Hz	 	230 V CHAIN GRINDER <b>1150920</b>
120 V~ 60 Hz	 <small>LISTED GRINDING MACHINE 41DA</small>	120 V CHAIN GRINDER <b>1150930</b>

- Electrical chain grinder dedicated to the most demanding professional market.  
An exclusive hydraulic system ensures automatic chain locking when the machine head is lowered quickening working time by up to 50%. Suitable for all chain pitches and types.

STANDARD PACKING

1 PC. PER BOX





Box packaging



PROVIDED WITH FOLLOWING ITEMS		P/N
	GRINDING WHEELS 1/4" - 3/8" - .325" chains for depth gauge	<b>1005231</b> <b>1005232</b>
	TEMPLATE	<b>1112001</b>
	DRESSING STONE	<b>1005040</b>
	WRENCH HEX. 4 HEX. 5	<b>3052004</b> <b>3052005</b>

## Speed master





DESCRIPTION		P/N
230 V~ 50 Hz	 	<b>230 V</b> CHAIN GRINDER <b>1190900</b>
		<b>120 V</b> CHAIN GRINDER <b>1190901</b>

- ▶ Electrical chain grinder.  
Easy to use, compact and powerful, suitable for any type of saw chain.  
The machine is supplied assembled.

STANDARD PACKING:	1 PC. PER BOX	
MASTER SHIPPER:	6 UNITS PER BOX	

Box packaging



PROVIDED WITH FOLLOWING ITEMS		P/N
	GRINDING WHEELS 1/4" - .325" chains	<b>1190051</b>
	TEMPLATE	<b>1112001</b>
	DRESSING STONE	<b>1005040</b>



## Bar mini grinder



Box packaging



DESCRIPTION		P/N
230 V~ 50 Hz	CE TUV	230 V CHAIN GRINDER <b>1195903</b>
		120 V CHAIN GRINDER <b>1195902</b>
12 V ---	CE	12 V CHAIN GRINDER <b>1195900</b>

- This unit allows you to sharpen saw chains without removing the chain from the bar. It combines professional characteristics, such as precision and high-power of the motor, with low cost and handiness required for the DIY market.

Also available in a 12 VDC version, for connecting to a battery.

STANDARD PACKING



1 PC. PER BOX















MASTER SHIPPER:





6 UNITS PER BOX



PROVIDED WITH FOLLOWING ITEMS	P/N
	GRINDING WHEELS 1/4" - .325" chains <b>1190051</b>
	TEMPLATE <b>1112001</b>
	DRESSING STONE <b>1005040</b>

## Grinding wheels

SUITABLE TO	WHEEL P/N	FOR CHAIN PITCH					FOR DEPTH GAUGE	WHEEL SIZE			TYPE	Q.TY PER CARTON		
		1/4"	.325"	3/8"	.404"	3/4"		Øext.	Øint.	Th.				
Speed Sharp Star Speed Sharp Speed Sharp Automatic	1005231	●	●	●				145 mm (5-3/4")	22,2 mm (7/8")	3,2 mm (1/8")		18		
	1005233		●	●	●			145 mm (5-3/4")	22,2 mm (7/8")	4,7 mm (3/16")		14		
	1005232						●		145 mm (5-3/4")	22,2 mm (7/8")		6 mm (1/4")		12
	01005000					●			145 mm (5-3/4")	22,2 mm (7/8")		8 mm (5/16")		15
	01005001		●	●	●				145 mm (5-3/4")	22,2 mm (7/8")	4,7 mm (3/16")		14	
	01005015	●	●	●					145 mm (5-3/4")	22,2 mm (7/8")	3,2 mm (1/8")		18	
	01005014		●	●	●				145 mm (5-3/4")	22,2 mm (7/8")	4,7 mm (3/16")		14	
	01005003	●	●	●					145 mm (5-3/4")	22,2 mm (7/8")	3,2 mm (1/8")		40	
	01005004		●	●	●				145 mm (5-3/4")	22,2 mm (7/8")	4,7 mm (3/16")		25	
	01005005						●		145 mm (5-3/4")	22,2 mm (7/8")	6 mm (1/4")		20	
Speed Master Bar Minigrinder	1190051	●	●	●				105 mm (4-1/8")	22,2 mm (7/8")	3,2 mm (1/8")		27		
	1190052		●	●	●			105 mm (4-1/8")	22,2 mm (7/8")	4,7 mm (3/16")		23		
	1190053						●		105 mm (4-1/8")	22,2 mm (7/8")		6 mm (1/4")		20
	01005006	●	●	●					105 mm (4-1/8")	22,2 mm (7/8")	3,2 mm (1/8")		40	
	01005007		●	●	●				105 mm (4-1/8")	22,2 mm (7/8")	4,7 mm (3/16")		25	

Grinding wheels specification	COLOR				
	CONSUMPTION	Low	Medium	Medium	High
	ABRASION CAPABILITY	Low	Medium	Medium	High
	CHAIN FINISHING	Good	Medium	Medium	Rough

## Special vise



DESCRIPTION	P/N
FOR 3/4" - 11BC CHAIN	<b>1150113</b>

► Special Speed Sharp device for 3/4" pitch chains.

STANDARD PACKING	1 PC. PER BOX	
------------------	---------------	---

PROVIDED WITH FOLLOWING ITEMS	P/N
-------------------------------	-----



GRINDING WHEELS	3/4" chains	<b>01005000</b>
-----------------	-------------	-----------------



TEMPLATE	gauge 3/4" template	<b>D00400000</b>
----------	---------------------	------------------

## Dressing stone and Template



DESCRIPTION	P/N
DRESSING STONE	<b>1005040</b>

STANDARD PACKING	BULK
------------------	------



DESCRIPTION	P/N
TEMPLATE	<b>1112001</b>

STANDARD PACKING	BULK
------------------	------

## Rivet master



DESCRIPTION		P/N
230 V~ 50 Hz	 	<b>230 V RIVET SPINNER 1131925</b>
		<b>120 V RIVET SPINNER 1131920</b>

- Professional electrical powered rivet spinner for saw chains. Equipment supplied in 2 parts: motor head and tripod-stand.



STANDARD PACKING

2 BOXES





- 1 BOX within MOTOR + MOTOR SUPPORT
- 1 BOX within TRIPOD + TABLE



PROVIDED WITH FOLLOWING ITEMS	P/N
 <p>KIT SPINROLL-ANYIL "A"</p>	<p>Suitable for chains pitch .325" - 3/8" - .404" - HARVESTER</p> <p><b>1131130</b></p>
 <p>KIT SPINROLL-ANYIL "B"</p>	<p>Suitable for chains pitch 1/4" - 90SG - 91 - 25AP</p> <p><b>1131131</b></p>

## Rivet spinner auto



DESCRIPTION		P/N
230 V~ 50 Hz 85W	 	<b>230 V RIVET SPINNER 11319002</b>
120 V~ 60 Hz 85W		<b>120 V RIVET SPINNER 11319003</b>

- ▶ Chain riveting at full speed by means of Compact Power Rivet Spinner. High speed reduction to spinning anvil for precise riveting at no risk of rivets burning. Easy to locate and fix at any workshop. High torque gearmotor combination for repairing chain up to .404" pitch. Cast iron body. Generative EAN13 code available

STANDARD PACKING

1 PC PER BOX



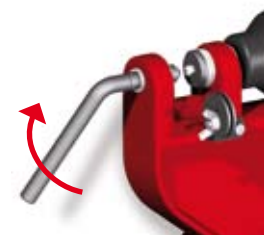

### Highlhts



▶ Easy to set and start up.



▶ Equipped with full series of thrust handles and spinning anvils.



PROVIDED WITH FOLLOWING ITEMS		P/N
	SPINNER INSERT 3/8" - .404" chains	<b>1029001E</b>
	SPINNER INSERT 1/4" - .325" chains	<b>1028002D</b>
	TAKE-UP HANDLE for: 1/4" - .325" chains for: 3/8" - .404" chains	<b>1025091</b> <b>1025092</b>

## Pro filing guide



DESCRIPTION	P/N
PRO FILE GUIDE <b>DELUXE</b>	<b>1147985</b>

- For precision saw chain filing with round files 6" - 8" as well as flat and triangular depth gauge files. Professional model.

STANDARD PACKING	CLAMSHELL - 1 PC.	
MASTER SHIPPER	24 PCS. PER BOX	





Clamshell packaging - 1 PC.



DESCRIPTION	P/N
PRO FILE GUIDE <b>SUPER</b>	<b>11079003</b>

- For precision saw chain filing with round files 6" - 8" as well as flat and triangular depth gauge files. Professional model.

STANDARD PACKING	CLAMSHELL - 1 PC.	
MASTER SHIPPER	24 PCS. PER BOX	



Clamshell packaging - 1 PC.





## Filing vise



DESCRIPTION	P/N
FILING VISE	<b>1090900</b>

- For professional and hobby users.  
Holds saw guide bar firmly when filing.  
Filing angle marks.

STANDARD PACKING	NYLON BAG - 1 PC.	
MASTER SHIPPER	12 PCS. PER BOX	

## File handles



DESCRIPTION		P/N
RED WITH 30° AND 35° FILING ANGLES		<b>1013006</b>
MASTER SHIPPER	250 PCS. PER BOX	
BLACK, PROFESSIONAL		<b>1013020</b>
STANDARD PACKING	NYLON BAG - 1 PC.	
MASTER SHIPPER	400 PCS. PER BOX	

## File holders



DESCRIPTION	P/N
PUSH ROD	<b>01013000</b>
MASTER SHIPPER	NYLON BAG - 50 PC.

ROUND FILE DIAMETER		FILE LENGTH		P/N
IN.	mm	IN.	mm	
5/32"	4	8"	200	<b>10109000</b>
11/64"	4.5	8"	200	<b>10199000</b>
3/16"	4,8	8"	200	<b>10119000</b>
13/64"	5.2	8"	200	<b>10139000</b>
7/32"	5,5	8"	200	<b>10129000</b>

► For quick filing of any saw chain type and pitch. Complete with handle and push rod.

MASTER SHIPPER	12 PCS. PER BOX	
----------------	-----------------	--

## File holders



15° mark on 7/32"  
P/N 1012962 file holder for  
chisel blade profile.  
See page 43.

ROUND FILE DIAMETER		FILE LENGTH		P/N
IN.	mm	IN.	mm	
5/32"	4	8"	200	<b>1010963</b>
11/64"	4.5	8"	200	<b>1019901</b>
3/16"	4.8	8"	200	<b>1011966</b>
13/64"	5.2	8"	200	<b>10139001</b>
7/32"	5.5	8"	200	<b>1012962</b>

► Complete with handle and file.

MASTER SHIPPER	50 PCS. PER BOX	
----------------	-----------------	--

## Flat file holders



ROUND FILE DIAMETER		FILE LENGTH		P/N
IN.	mm	IN.	mm	
5/32"	4	8"	200	<b>1010942</b>
11/64"	4.5	8"	200	<b>1019903</b>
3/16"	4.8	8"	200	<b>1011942</b>
13/64"	5.2	8"	200	<b>10139003</b>
7/32"	5.5	8"	200	<b>1012942</b>

► Without handle and file.

MASTER SHIPPER

100 PCS. PER BOX



## Dept gauge jointers

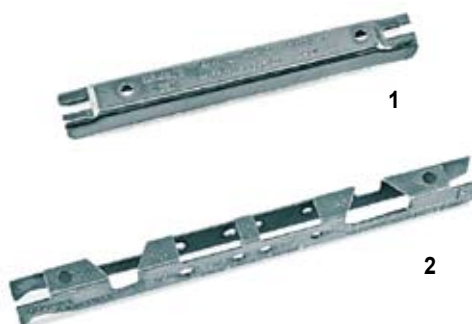

DEPTH SETTING		P/N
IN.	mm	
.025" - .030"	0,65 - 0,75	<b>1018001 (1)</b>
.025" - .030"	0,65 - 0,75	<b>1018003 (2)</b>
.035" - .040"	0,90 - 1,00	

- For an accurate depth control setting.
- (2) can be used as bar groove cleaner, file angles and files gauge.

MASTER SHIPPER

100 PCS. PER BOX



## Bar groove cleaner



DESCRIPTION	P/N
BAR GROOVE CLEANER	<b>1017001</b>

- This tool is useful for bar maintenance. Clears grooves and oil holes.

MASTER SHIPPER

300 PCS. PER BOX







## Steel chain breaker



DESCRIPTION	P/N
CHAIN BREAKER	<b>1020990</b>

- ▶ Bench type for shop use.  
With operating lever for fast and easy chain breaking.  
Complete with adjustable anvil and punches.

STANDARD PACKING	1 PC. PER BOX	
MASTER SHIPPER	10 UNITS PER BOX	



PROVIDED WITH FOLLOWING ITEMS	P/N
ADJUSTABLE ANVIL	<b>1020070</b>
WRENCHES	<b>3052003</b>
PUNCH - standard	<b>1020033E</b>
PUNCH - 1.1 mm / .043"	<b>1020189</b>

## Slotted anvil



DESCRIPTION	P/N
ADJUSTABLE ANVIL	<b>1020070</b>

- ▶ The adjustable vice provides the correct positioning for breaking any saw chain model and type.

STANDARD PACKING	BULK
------------------	------

## Punches



DESCRIPTION	P/N
BREAKER PUNCH	<b>1020033E</b>

- ▶ Punch for chain breaker for:  
1/4" - .325" - .354" - .404" - 7/16" - 1/2" chains.

STANDARD PACKING	BULK
------------------	------

BREAKER PUNCH mm 1	<b>1020189</b>
--------------------	----------------

- ▶ Punch for 1.1/.043 gauge chains.

STANDARD PACKING	BULK
------------------	------

## Steel rivet spinner



DESCRIPTION	P/N
RIVET SPINNER	<b>1025990</b>

► With built-in thrust bearing for minimum friction, giving fast and effortless spinning. Complete with take-up handle and spinner insert for: .354" - 3/8" - .404" - 7/16" and 1/2" chains.

STANDARD PACKING	1 PC. PER BOX	
MASTER SHIPPER	10 UNITS PER BOX	



PROVIDED WITH FOLLOWING ITEMS	P/N
SPINNER INSERT	<b>1029001E</b>
TAKE-UP HANDLE	<b>1027001D</b>

## Take up handles



DESCRIPTION	P/N
TAKE-UP HANDLE FOR: 1/4" - .325 CHAINS	<b>1026001D</b>
TAKE-UP HANDLE FOR: .354" - 3/8" - .404" - 7/16" - 1/2" CHAINS	<b>1027001D</b>
STANDARD PACKING	BULK
MASTER SHIPPER	10 PCS.

## Spinner inserts



DESCRIPTION	P/N
SPINNER INSERT FOR: 1/4" - .325 CHAINS	<b>1028002D</b>
SPINNER INSERT FOR: .354" - 3/8" - .404" - 7/16" - 1/2" CHAINS	<b>1029001E</b>
STANDARD PACKING	BULK
MASTER SHIPPER	10 PCS.

## Pocket chain breaker



DESCRIPTION	P/N
POCKET CHAIN BREAKER	<b>1030900</b>

- ▶ Portable chain breaker for saw chains.  
Used for the following chains: 3/8" - .404" - 7/16" - 1/2".

STANDARD PACKING          PLASTIC HOLSTER - 1 SET

## Filing vise



DESCRIPTION	P/N
FILING VISE	<b>1090920</b>

- ▶ Simple, easy, useful and not expensive. Already available ex stock.  
The Precision Tooling filing vise makes hand sharpening in the workshop faster and more precise.

STANDARD PACKING

BLISTER



MASTER SHIPPER

10 UNITS



## Grease gun



Box packaging



DESCRIPTION	PACKAGING	Q.TY per carton	P/N
GREASE GUN	NEUTRAL CARTON	800 Pcs	<b>1108000</b>
GREASE GUN	CARTON	25 Pcs	<b>1108001</b>

- ▶ Handy plastic item for sprocket tip guide bars; refillable plunger type.

## Grease gun



DESCRIPTION	P/N
GREASE GUN	<b>1108025</b>

- ▶ Grease gun for sprocket nose guide bars.

MASTER SHIPPER

50 PCS PER BOX



## Bar guard standard



DIMENSIONS LENGHT X HEIGHT		P/N
IN.	mm	
12" x 3.6"	300 x 91	<b>1144033</b>
14" x 3.6"	350 x 91	<b>1144038</b>
16" x 3.6"	400 x 91	<b>1144156</b>
16" x 4.7"	400 x 120	<b>1144043</b>
18" x 4.7"	450 x 120	<b>1144048</b>
20" x 4.7"	500 x 120	<b>1144053</b>

► For safety purposes and to protect the saw bar and chain.

MASTER SHIPPER

48 PCS. PER BOX



## Wedges



DEPTH SETTING		Q.TY per carton	P/N
IN.	mm		
5.5"	140	35	<b>1055903A</b>
7.5"	190	25	<b>1055901A</b>
10.5"	270	14	<b>1055904A</b>

► Tough plastic; durable and safe felling and bucking without demaging the chain.

## Lawnmower blade balancer



DESCRIPTION	P/N
LAWNMOWER BLADE BALANCER	<b>0580000</b>

► Improved version for any kind of lawnmower blade - 6 magnets allow higher stability.

STANDARD PACKING

1 PC. PER BOX



## Universal nylon piston stop



DESCRIPTION		P/N
UNIVERSAL NYLON PISTON STOP		<b>1111007</b>
STANDARD PACKING	NYLON BAG - 10 PCS.	

## Nylon piston stop



DESCRIPTION		P/N
NYLON PISTON STOP		<b>1111003</b>
STANDARD PACKING	NYLON BAG - 10 PCS.	

## Metal piston stop



DESCRIPTION		P/N
METAL PISTON STOP		<b>1111008</b>
STANDARD PACKING	NYLON BAG - 10 PCS.	

## Piston ring clamp set



DESCRIPTION	P/N
SET	<b>1042901</b>

► Useful for assembling pistons and cylinders. 4 size of clamps.

STANDARD PACKING PLASTIC HOLSTER - 1 SET

MASTER SHIPPER 50 SET PER BOX 

## Pressure gauge



DESCRIPTION	P/N
PRESSURE GAUGE	<b>1043900</b>

► Gauge for carburetor and cylinder testing.

STANDARD PACKING 1 PC. PER BOX 

## Pressure gauge kit



DESCRIPTION	P/N
PRESSURE GAUGE KIT	<b>1081900</b>

► Handy plastic item for sprocket tip guide bars; refillable plunger type.

STANDARD PACKING 1 KIT PER PLASTIC BOX



GARDENING





Whips trimmer head .....	24
Whips trimmer head adaptor .....	26
PROWhips trimmer head - universal mounting .....	27
Whips trimmer head SF25 .....	28
PRODisc trimmer head - universal mounting .....	29
Tap-n-go trimmer head Ø109 mm .....	30
Tap-n-go trimmer head Universal mounting Ø130 mm .....	31
Tap-n-go trimmer head Ø130 mm .....	32
Tap-n-go Super PRO Universal mounting Ø130 mm .....	33
Tap-n-go Super PRO Ø130 mm .....	34
Tap-n-go trimmer head Ø160 mm .....	35
MINI Tap-n-go trimmer head.....	36
Manual head pro type .....	37
Guide list for head adaptors .....	38
Round nylon line .....	41
Pro-trim disk .....	45
Nylon blades .....	46
Steel blades .....	47
Polycarbonate face shields.....	52
Metal net face shields .....	53
Ear muffs .....	54
Safety helmet.....	54
Brushcutter shoulder straps.....	55
Blade guards .....	56
Shin Guards For hobbyists and professionals .....	57
Blade supports.....	57
Plastic cans .....	58
Plastic cans .....	59
EASY Fill Funnel self-closing spout.....	60
Funnel assy filter .....	60



## Packaging & Shipment

### Type of packaging

	Carton box
	Plastic clamshell / Blister
	Nylon bag

### Type of shipment and minimum q.ty per order

	Carton master shipper
---	-----------------------





## Whips trimmer head

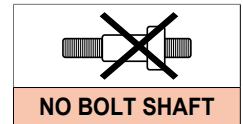

DESCRIPTION	P/N
NYLON / NYLON HEAD	<b>5090901</b>

► Trimmer head, universal mounting without adaptor, centering bore for both 20-25,4 mm. Delivered complete with 6 nylon whips ( $\varnothing$  3 mm) of 300mm each and kit of adaptor washers and reduction rings. Suggested for trimmers of maximum 25 c.c.



STANDARD PACKING	NYLON BAG - 1PC.	
MASTER SHIPPER	50 PCS. PER BOX	

## Whips trimmer head



**NEW**

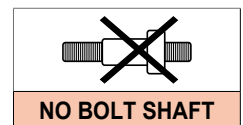

DESCRIPTION	P/N
ALUMINIUM / NYLON HEAD	<b>50909007</b>

► Professional trimmer head, universal mounting without adaptor, centering bore for both 20-25,4 mm. Delivered complete with 10 nylon whips ( $\varnothing$  3,3 mm) of 300 mm each and kit of adaptor washers and reduction rings. Suggested for brushcutters up to 35 c.c.



STANDARD PACKING	NYLON BAG - 1PC.	
MASTER SHIPPER	50 PCS. PER BOX	

## Replacement parts for whips trimmer head



DESCRIPTION	P/N
Kit of adaptor washers and reduction rings	<b>K00401008</b>
Kit of adaptor washers and reduction rings	<b>5025007</b>
$\varnothing$ 3 mm Set of 50 nylon whips each, 300 mm long	<b>5200040</b>
$\varnothing$ 3,3 mm Set of 50 nylon whips each, 300 mm long	<b>5200041</b>
Plastic knob $\varnothing$ 80 mm	<b>5090012</b>



## Whips trimmer head

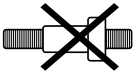



DESCRIPTION	P/N
ALUMINIUM / ALUMINIUM HEAD	<b>50909006</b>
<p>▶ Trimmer head, universal mounting without adaptor, centering bore for both 20-25,4 mm. Delivered complete with 10 nylon whips (<math>\varnothing</math> 3,3 mm) of 300 mm each and kit of adaptor washer and reduction ring. Suggested for trimmers over 33 c.c.</p>	 <b>NO BOLT SHAFT</b>

STANDARD PACKING	NYLON BAG - 1PC.	
MASTER SHIPPER	50 PCS. PER BOX	

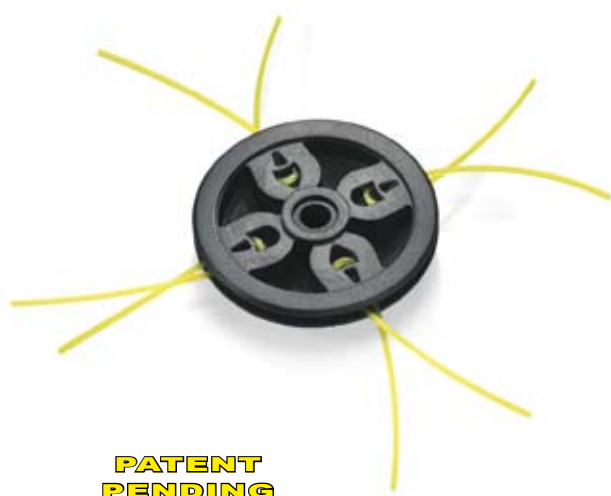
## Whips trimmer head

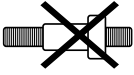

DESCRIPTION	P/N
NYLON HEAD	<b>5090912</b>
<p>▶ New concept patented nylon head for brushcutters up to 33 cc. Modern design combined with high cutting performance and minimum weight. Universal mounting without adaptor, centering bore for both 20-25,4 mm. Delivered complete with 4 nylon whips (<math>\varnothing</math> 3 mm) of 300 mm each and kit of adaptor washer and reduction ring. Suggested for brushcutters up to 33 c.c.</p>	 <b>NO BOLT SHAFT</b>

STANDARD PACKING	NYLON BAG - 1PC.	
MASTER SHIPPER	50 PCS. PER BOX	

## Replacement parts for whips trimmer head

DESCRIPTION	P/N
Kit of adaptor washers and reduction rings	<b>K00401008</b>
Kit of adaptor washers and reduction rings	<b>5025007</b>
$\varnothing$ 3 mm Set of 50 nylon whips each, 300 mm long	<b>5200040</b>
$\varnothing$ 3,3 mm Set of 50 nylon whips each, 300 mm long	<b>5200041</b>
Aluminium knob $\varnothing$ 80 mm	<b>5090014</b>





## Whips trimmer head

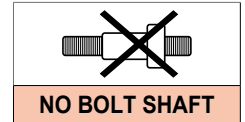

DESCRIPTION	P/N
ALUMINIUM / ALUMINIUM HEAD	<b>5090911</b>

► Professional trimmer head, universal mounting without adaptor, centering bore for both 20-25,4 mm. Multi stage line extension for mulching purpose. Delivered complete with 10 nylon whips (∅ 3,3 mm) of 300 mm each and kit of adaptor washers and reduction rings. Suggested for brushcutters over 40 c.c.



STANDARD PACKING	NYLON BAG - 1PC.	
MASTER SHIPPER	50 PCS. PER BOX	

## Replacement parts for whips trimmer head

DESCRIPTION	P/N
Kit of adaptor washers and reduction rings	<b>K00401008</b>
Kit of adaptor washers and reduction rings	<b>5025007</b>
∅ 3 mm Set of 50 nylon whips each, 300 mm long	<b>5200040</b>
∅ 3,3 mm Set of 50 nylon whips each, 300 mm long	<b>5200041</b>
Aluminium knob ∅ 80 mm	<b>5090014</b>



## Whips trimmer head adaptor



DESCRIPTION	P/N
SUITABLE FOR ALUMINIUM / NYLON HEAD	<b>5090019</b>

STANDARD PACKING	NYLON BAG - 1PC.	
MASTER SHIPPER	10 PCS. PER BOX	

## PROWhips trimmer head - universal mounting



### DESCRIPTION

P/N

ALUMINIUM / ALUMINIUM HEAD

**50909005**

- ▶ Most comfortable manual head disassembling operation for easy fixed line loading. Cross-over lines ensures higher line resistance and flexibility. Centering bore for both 20-25,4 mm.

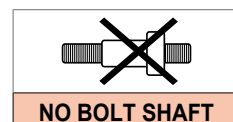

- ▶ Larger knob for more comfortable assembling and disassembling.

STANDARD PACKING

NYLON BAG - 1PC.



MASTER SHIPPER

50 PCS. PER BOX



### OPTIONS

2 LINES

4 LINES

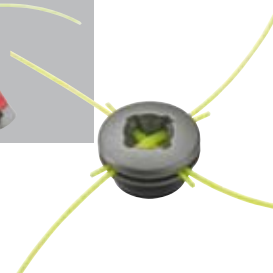
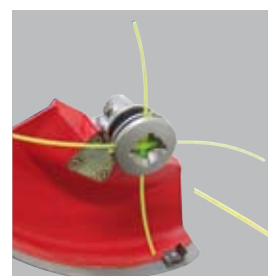
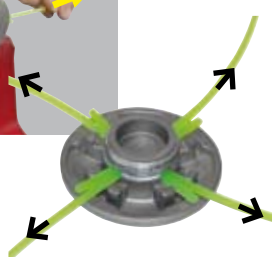
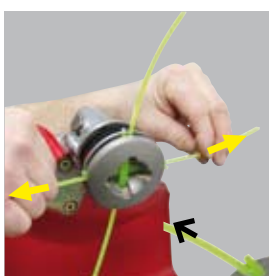

## Replacement parts for whips trimmer head

DESCRIPTION	P/N
Kit of adaptor washers and reduction rings	<b>K00401008</b>
∅ 3 mm Set of 50 nylon whips each, 300 mm long.	<b>5200040</b>
∅ 3,3 mm Set of 50 nylon whips each, 300 mm long.	<b>5200041</b>
Aluminium knob ∅80mm.	<b>C00012017</b>



## Whips trimmer head SF25

### PREPARATION

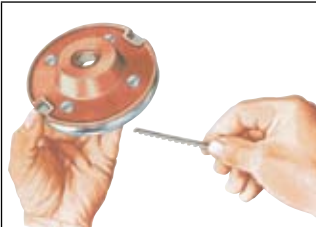

For optimal results, use square nylon whips length 400mm

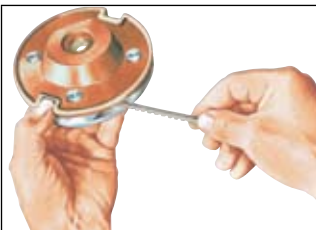

Press in the lateral metal buttons and insert new pre-cut whip

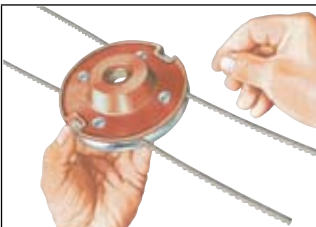

Ensure that the whip is the same length of each side of the head, and beginning work!

### DESCRIPTION

ALUMINIUM / NYLON HEAD

### P/N

50619000

► Universal Trimmer head, universal mounting without adaptor.

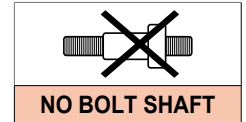

NO BOLT SHAFT

STANDARD PACKING

CLAMSHELL - 1 PC.



MASTER SHIPPER

50 PCS. PER BOX

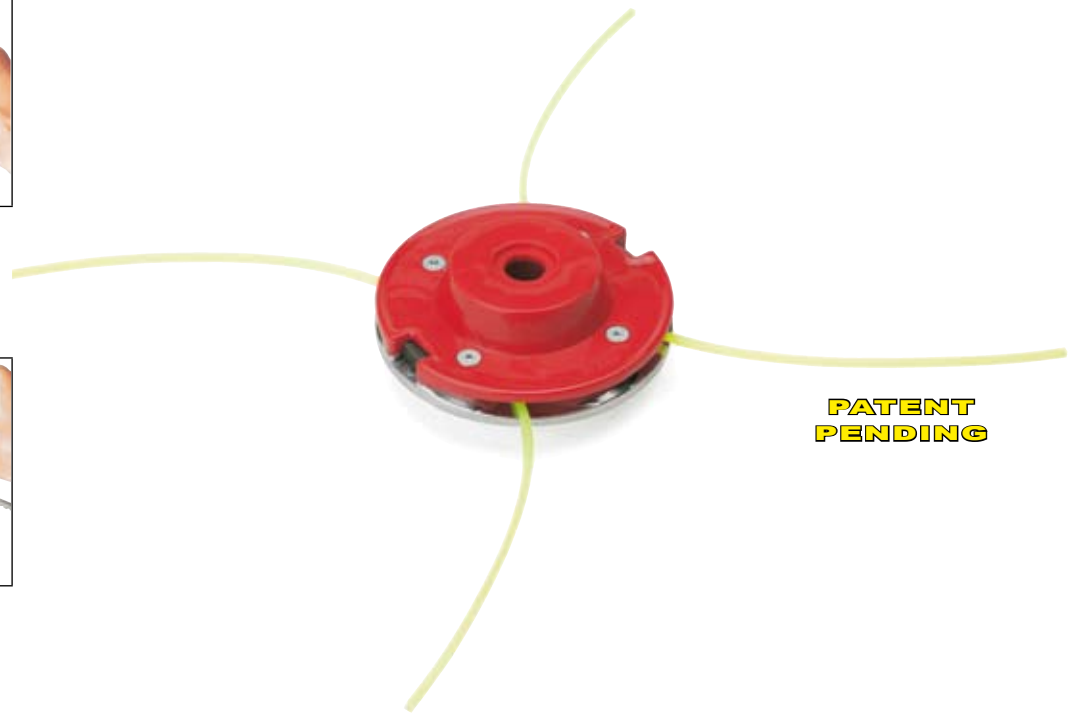

## Replacement parts for whips trimmer head

### DESCRIPTION

### P/N

∅ 3 mm Set of 25 nylon whips each, 400 mm long

5200230



## PRODiSC trimmer head - universal mounting

**NEW**



Easy and fast assembling and disassembling

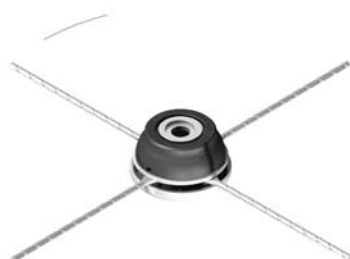

Cut diameter:  
Ø 380mm / Ø 420mm

### DESCRIPTION

### P/N

ALUMINIUM / ALUMINIUM HEAD - Cutting Ø 380mm

**50259000**

ALUMINIUM / ALUMINIUM HEAD - Cutting Ø 420mm

**50259004**

- ▶ Trimmer head evolution: One swing blade head for four different purposes.  
Centering bore for both 20-25,4 mm
- Worm shaped blade: handy and resistant
- knife shaped blade: best cut performance
- Larger knob for more comfortable assembling and disassembling.
- ▶ Delivered complete with: 4 worm shaped blades, 4 knife shaped blades and kit of adaptor washers.

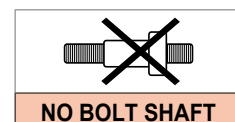

STANDARD PACKING

NYLON BAG - 1PC.



MASTER SHIPPER

50 PCS. PER BOX



## Replacement parts for whips trimmer head

DESCRIPTION	P/N
Kit of adaptor washers and reduction rings	<b>K00401008</b>
Worm shaped blade L = 150mm (4 PCS)	<b>05220000</b>
Worm shaped blade L = 170mm (4 PCS)	<b>05220001</b>
Aluminium knob Ø85mm	<b>C00012019</b>



## Tap-n-go trimmer head Ø109 mm



DESCRIPTION	P/N
M 7 x 1 Left male	<b>50719025</b>
M 8 x 1.25 Left male (fits EMAK only)	<b>50719015</b>
M 8 x 1.25 Left female	<b>50719016</b>
M 8 x 1.25 Left male	<b>50719017</b>
M 10 x 1.00 Left female (fits STIHL only)	<b>50719018</b>
M 10 x 1.25 Left female	<b>50719019</b>
M 10 x 1.25 Left female (fits HU only)	<b>50719020</b>
M 10 x 1.25 Left male	<b>50719021</b>
M 10 x 1.50 Left female (fits HU only)	<b>50719022</b>
3/8"- 24 Left female	<b>50719023</b>
M 10 x 1,00 Left female	<b>50719034</b>
M 10 x 1,50 Left male (fits MC only)	<b>50719035</b>

► Double line nylon head Ø 109 mm complete with adaptor bolt - Ø 2 mm nylon line.

STANDARD PACKING

NYLON BAG - 1PC.



MASTER SHIPPER

40 PCS. PER BOX



## Spare parts

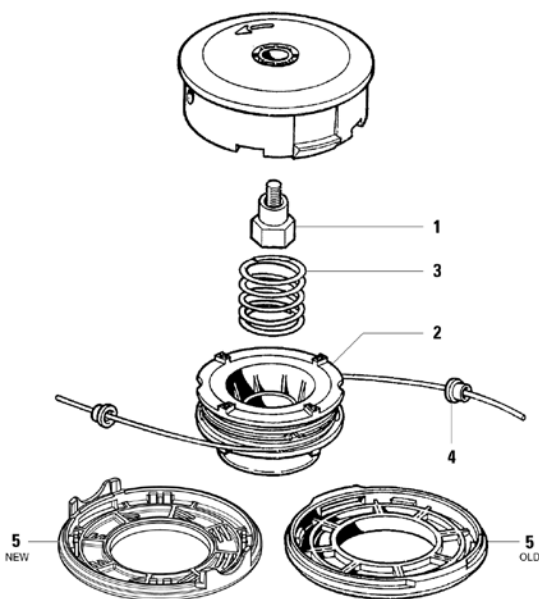

DESCRIPTION	P/N
<b>1</b> Adaptor M 7 x 1 Left male	<b>5070021</b>
Adaptor M 8 x 1.25 Left male (fits EMAK only)	<b>5070006</b>
Adaptor M 8 x 1.25 Left female	<b>5070011</b>
Adaptor M 8 x 1.25 Left male	<b>5070020</b>
Adaptor M 10 x 1.00 Left female (fits STIHL only)	<b>5070026</b>
Adaptor M 10 x 1.25 Left female	<b>5070008</b>
Adaptor M 10 x 1.25 Left female (fits HU only)	<b>5070024</b>
Adaptor M 10 x 1.25 Left male	<b>5070009</b>
Adaptor M 10 x 1.50 Left female (fits HU only)	<b>5070032</b>
Adaptor 3/8"-24 Left female	<b>I00003000</b>
<b>2</b> Spool without line	<b>B01201002</b>
<b>3</b> Spring	<b>M00200002</b>
<b>4</b> Line retainer	<b>5070005</b>
<b>5</b> Upper cover (until 0512007 OLD)	<b>C00205001</b>
<b>5</b> Upper cover (from 06/2007 NEW)	<b>C00205003</b>

## Tap-n-go trimmer head Universal mounting Ø130 mm



DESCRIPTION	P/N
PRO UNIVERSAL HEAD	<b>5070911</b>

- ▶ Semi-automatic head "pro universal".  
Tape-n-go double line head, universal mounting without adaptor, centering bore for both 20÷25.4 mm - Ø 2,4 mm nylon line.

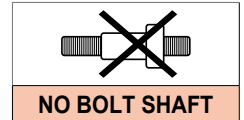

STANDARD PACKING      NYLON BAG - 1PC.



MASTER SHIPPER      40 PCS. PER BOX



## Spare parts

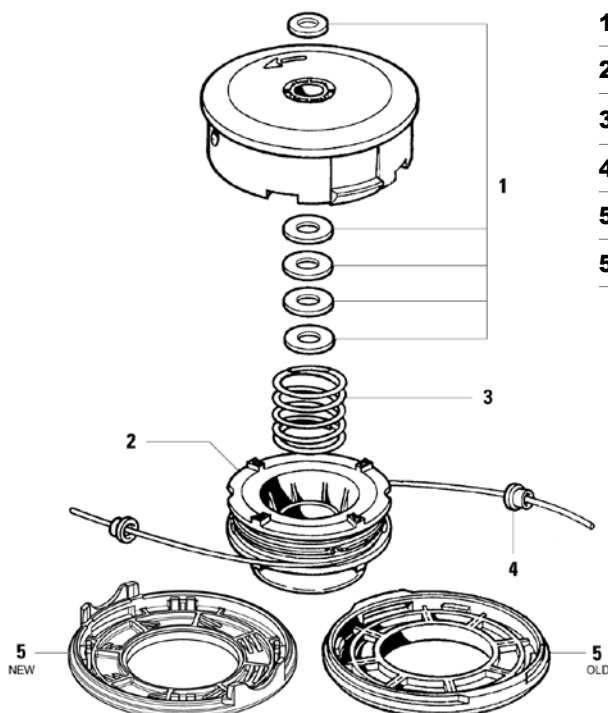

DESCRIPTION	P/N
<b>1</b> Kit of adaptor washers and reduction rings	<b>K00401008</b>
<b>2</b> Spool without line	<b>5070003</b>
<b>3</b> Spring	<b>5070004</b>
<b>4</b> Line retainer	<b>5070005</b>
<b>5</b> Upper cover OLD	<b>5070038</b>
<b>5</b> Upper cover NEW	<b>C00205002</b>



## Tap-n-go trimmer head Ø130 mm



DESCRIPTION	P/N
M 8 x 1.25 Left male (fits EMAK only)	<b>5070901</b>
M 8 x 1.25 Left female	<b>5070902</b>
M 8 x 1.25 Left male	<b>5070907</b>
M 8 x 1.25 Right male	<b>5070924</b>
M 10 x 1.00 Left female (fits STIHL only)	<b>5070908</b>
M 10 x 1.25 Left female	<b>5070903</b>
M 10 x 1.25 Left female (fits HU only)	<b>5070916</b>
M 10 x 1.25 Left male	<b>5070904</b>
M 10 x 1.50 Left male (fits MC only)	<b>5070909</b>
M 10 x 1.50 Left female (fits HU only)	<b>5070917</b>
M 12 x 1.25 Left female (fits XENOAH only)	<b>50709003</b>
M 12 x 1.50 Left female + M 14 x 1.50 Left female	<b>5070905</b>
M 12 x 1.75 Left female (fits HU only)	<b>5070913</b>
NEUTRAL delivered without adaptor	<b>5070910</b>

► Double line nylon head Ø 130 mm complete with adaptor bolt - Ø 2,4 mm nylon line.

STANDARD PACKING

NYLON BAG - 1PC.



MASTER SHIPPER

40 PCS. PER BOX



## Spare parts

DESCRIPTION	P/N
<b>1</b> Adaptor M 8 x 1.25 Left male (fits EMAK only)	<b>5070006</b>
Adaptor M 8 x 1.25 Left female	<b>5070011</b>
Adaptor M 8 x 1.25 Left male	<b>5070020</b>
Adaptor M 8 x 1.25 Right male	<b>5070044</b>
Adaptor M 10 x 1.00 Left female (fits STIHL only)	<b>5070026</b>
Adaptor M 10 x 1.25 Left female	<b>5070008</b>
Adaptor M 10 x 1.25 Left female (fits HU only)	<b>5070024</b>
Adaptor M 10 x 1.25 Left male	<b>5070009</b>
Adaptor M 10 x 1.50 Left male (fits MC only)	<b>5070027</b>
Adaptor M 10 x 1.50 Left female (fits HU only)	<b>5070032</b>
Adaptor M 12 x 1.25 Left female (fits XENOAH only)	<b>100003001</b>
Adaptor M 12 x 1.50 Left female	<b>5070010</b>
Adaptor M 12 x 1.75 Left female (fits HU only)	<b>5070028</b>
Adaptor M 14 x 1.50 Left female (fits STIHL only)	<b>5070039</b>
<b>2</b> Spool without line	<b>5070003</b>
<b>3</b> Spring	<b>5070004</b>
<b>4</b> Line retainer	<b>5070005</b>
<b>5</b> Upper cover (until 0512007 OLD)	<b>5070002</b>
<b>5</b> Upper cover (from 06/2007 NEW)	<b>C00205002</b>

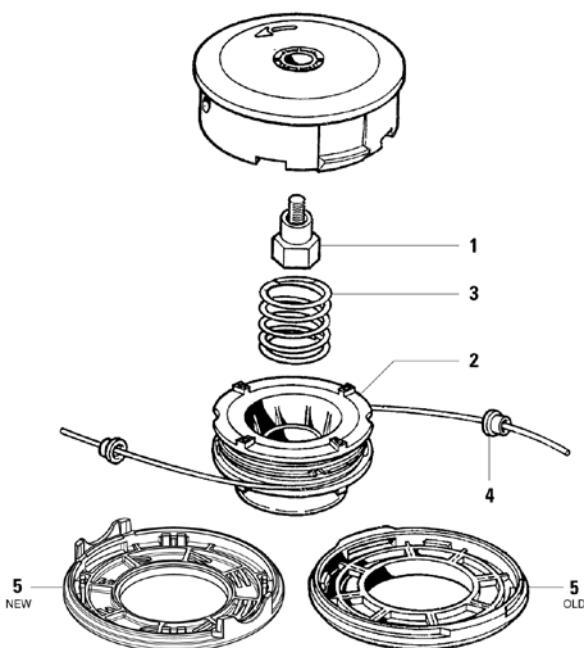

## Tap-n-go Super PRO Universal mounting Ø130 mm

**NEW**



Line spool interchangeable with spool p/n 5070003 of traditional tecomec tap-n-go heads and also available separately. wrapping capacity increased +30% !

Zinc plated steel insert

DESCRIPTION	P/N
Tap-n-go "HD SP" universal head	<b>50769012</b>

- ▶ Semi-automatic head "pro universal" double line head, universal mounting with out adaptor centering fore fot both 20÷25 mm - ø 2.4 mm nylon line. Delivered complete with kit of adaptor washers.

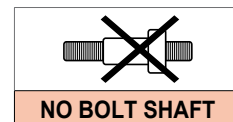

**NO BOLT SHAFT**

STANDARD PACKING

NYLON BAG - 1PC.



MASTER SHIPPER

30 PCS. PER BOX



### Spare parts

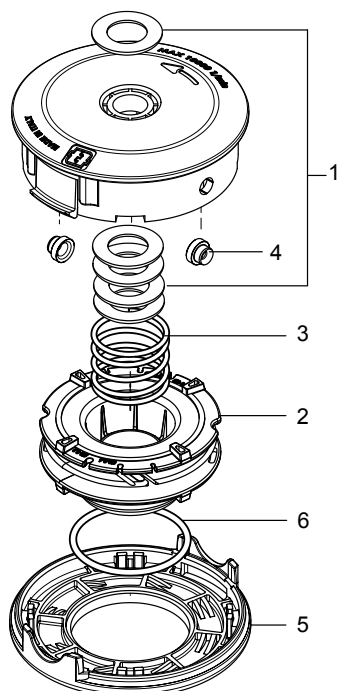

DESCRIPTION	P/N
<b>1</b> Kit of adaptor washers and reduction rings	<b>K00401008</b>
<b>2</b> Spool without line	<b>B01201003</b>
<b>3</b> Spring	<b>M00200005</b>
<b>4</b> Line retainer	<b>5070005</b>
<b>5</b> Lower cover	<b>C00205002</b>
<b>6</b> O-ring	<b>G00001052</b>

## Tap-n-go Super PRO Ø130 mm

**NEW**



Line spool interchangeable with spool p/n 5070003 of traditional tecomec tap-n-go heads and also available separately. wrapping capacity increased +30% !

Zinc plated steel insert

DESCRIPTION	P/N
"HD SP" head M12X1.25 LH.F. (fits XENOAH only)	<b>50769008</b>
"HD SP" head M8 LH.M. (fits EMAK only)	<b>50769000</b>
"HD SP" head M8 LH.F.	<b>50769001</b>
"HD SP" head M10X1.25 LH.F.	<b>50769004</b>
"HD SP" head M10X1,25 LH.M	<b>50769006</b>
"HD SP" head M12X1.5/M14X1.5 LH/F	<b>50769009</b>
"HD SP" head M8 LH.M	<b>50769002</b>
"HD SP" head M10X1 LH.F. (fits STIHL only)	<b>50769003</b>
"HD SP" head M10X1,5 LH.M. (fits MC only)	<b>50769007</b>
"HD SP" head M12X1,75 LH/F (fits HU only)	<b>50769010</b>
"HD SP" head M10X1,25 LH/F (fits HU only)	<b>50769005</b>
"HD SP" head M10X1,5 LH/F (fits HU only)	<b>50769013</b>
"HD SP" head NEUTRAL without adaptor	<b>50769011</b>

► Double line nylon head Ø 130 mm complete with adaptor bolt - Ø 2,4 mm nylon line.

STANDARD PACKING

NYLON BAG - 1PC.



MASTER SHIPPER

30 PCS. PER BOX



## Spare parts

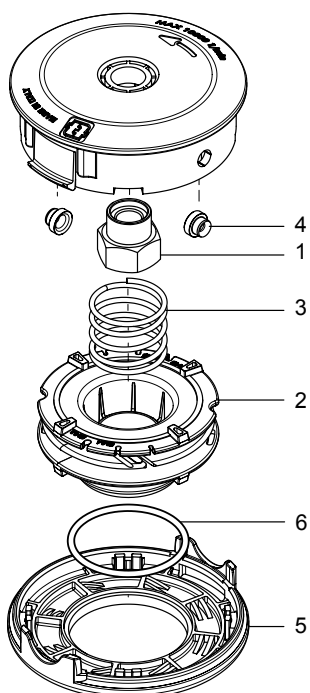

DESCRIPTION	P/N
<b>1</b> Adaptor M 8 x 1.25 Left male (fits EMAK only)	<b>I00003002</b>
Adaptor M 8 x 1.25 Left female	<b>5070011</b>
Adaptor M 8 x 1.25 Left male	<b>5070020</b>
Adaptor M 8 x 1.25 Right male	<b>5070044</b>
Adaptor M 10 x 1.00 Left female (fits STIHL only)	<b>5070026</b>
Adaptor M 10 x 1.25 Left female	<b>5070008</b>
Adaptor M 10 x 1.25 Left female (fits HU only)	<b>5070024</b>
Adaptor M 10 x 1.25 Left male	<b>5070009</b>
Adaptor M 10 x 1.50 Left male (fits MC only)	<b>5070027</b>
Adaptor M 10 x 1.50 Left female (fits HU only)	<b>5070032</b>
Adaptor M 12 x 1.25 Left female (fits XENOAH only)	<b>I00003001</b>
Adaptor M 12 x 1.50 Left female	<b>5070010</b>
Adaptor M 12 x 1.75 Left female (fits HU only)	<b>5070028</b>
Adaptor M 14 x 1.50 Left female (fits STIHL only)	<b>5070039</b>
<b>2</b> Spool without line	<b>B01201003</b>
<b>3</b> Spring	<b>M00200005</b>
<b>4</b> Line retainer	<b>5070005</b>
<b>5</b> Lower cover	<b>C00205002</b>
<b>6</b> O-ring	<b>G00001052</b>



## Tap-n-go trimmer head Ø160 mm



Suggested for brush-cutters into 40 cc

DESCRIPTION	P/N
M 8 x 1.25 Left male (fits EMAK only)	<b>5075902</b>
M 12 x 1.75 Left female (fits HU only)	<b>50759000</b>
NEUTRAL delivered without adaptor	<b>5075901</b>

► Double line nylon head ø 160 mm - ø 3 mm nylon line.

STANDARD PACKING	NYLON BAG - 1PC.	
MASTER SHIPPER	25 PCS. PER BOX	

## Spare parts

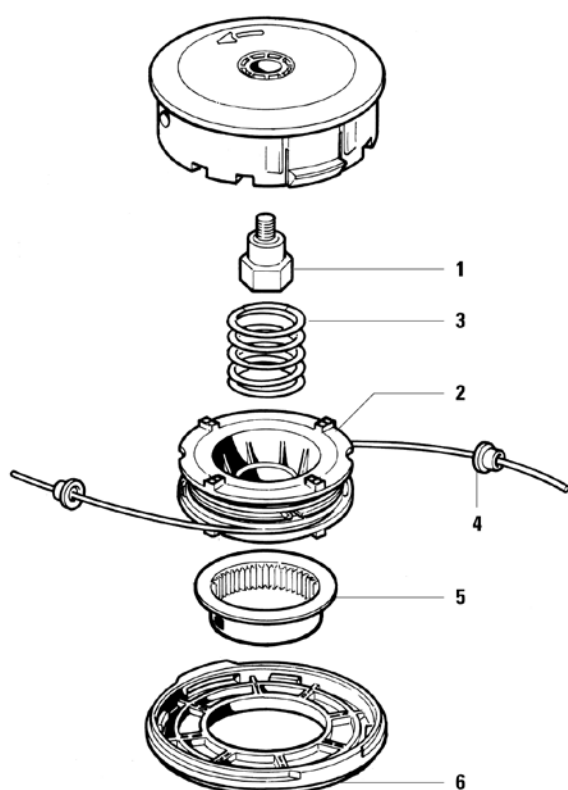

DESCRIPTION	P/N
<b>1</b> Adaptor M 8 x 1.25 Left male (fits EMAK only)	<b>5070006</b>
Adaptor M 8 x 1.25 Left female	<b>5070011</b>
Adaptor M 8 x 1.25 Left male	<b>5070020</b>
Adaptor M 10 x 1.00 Left female (fits STIHL only)	<b>5070026</b>
Adaptor M 10 x 1.25 Left female	<b>5070008</b>
Adaptor M 10 x 1.25 Left male	<b>5070009</b>
Adaptor M 10 x 1.50 Left male (fits MC only)	<b>5070027</b>
Adaptor M 10 x 1.50 Left female (fits HU only)	<b>5070032</b>
Adaptor M 12 x 1.25 Left female (fits XENOAH only)	<b>100003001</b>
Adaptor M 12 x 1.50 Left female	<b>5070010</b>
Adaptor M 12 x 1.75 Left female	<b>5070028</b>
Adaptor M 14 x 1.50 Left female	<b>5070039</b>
<b>2</b> Spool without line	<b>5075003</b>
<b>3</b> Spring	<b>5075006</b>
<b>4</b> Line retainer	<b>5070005</b>
<b>5</b> Knob	<b>5075004</b>
<b>6</b> Upper cover	<b>5075002</b>

## MINI Tap-n-go trimmer head

**NEW**



Clamshell packaging - 1 PC.



### DESCRIPTION

P/N

► Any Trimmer Head is supplied single packed in a nice clamshell for Wall Display Package.

suitable to: **Homelite** DA03001 / Da03001  
A Dual line head with 5/16" Bump knob fits ST155, ST165, ST285 and more. Also Black & Dekker

**50909001**

STANDARD PACKING

CLAMSHELL - 1 PC.



MASTER SHIPPER

40 PCS. PER BOX



**NEW**



Clamshell packaging - 1 PC.



### DESCRIPTION

P/N

► Any Trimmer Head is supplied single packed in a nice clamshell for Wall Display Package.

suitable to: **RYOBI** 153577 Dual line head with 5/16" Bump knob. Fits 700R, 710R, 720R, 740R, 75R, 760R, 765R, 766R, 770R, 920R, 970R, CS720R, SS720R and more.

**50909003**

STANDARD PACKING

CLAMSHELL - 1 PC.



MASTER SHIPPER

40 PCS. PER BOX



**NEW**



Clamshell packaging - 1 PC.



### DESCRIPTION

P/N

► Any Trimmer Head is supplied single packed in a nice clamshell for Wall Display Package.

suitable to: **McCulloch** two line bump feed with 1/4" Bump knob. Fits Promac, MK1, MK2 & MK3.

**50909004**

STANDARD PACKING

CLAMSHELL - 1 PC.



MASTER SHIPPER

40 PCS. PER BOX



## Manual head pro type



DESCRIPTION	P/N
M 7 x 1.00 Left male	<b>5030901</b>
M 8 x 1.25 Left male	<b>5030903</b>
M 8 x 1.25 Left male (fits EMAK only)	<b>5030904</b>
M 8 x 1.25 Left female	<b>5030907</b>
M 10 x 1.00 Left female (fits HU only)	<b>5030911</b>
M 10 x 1.00 Left female (fits Stihl only)	<b>5030910</b>
M 10 x 1.25 Left female	<b>5030913</b>
M 10 x 1.25 Left male	<b>5030914</b>
M 10 x 1.50 Left female	<b>5030915</b>
M 12 x 1.50 Left female (fits Stihl only)	<b>5030917</b>
M 12 x 1.75 Left female (fits HU only)	<b>5030918</b>

► Double line nylon head complete with adaptor bolt, aluminium knob -  $\varnothing$  2,4 mm nylon line.

STANDARD PACKING

NYLON BAG - 1PC.



MASTER SHIPPER

50 PCS. PER BOX



## Spare parts

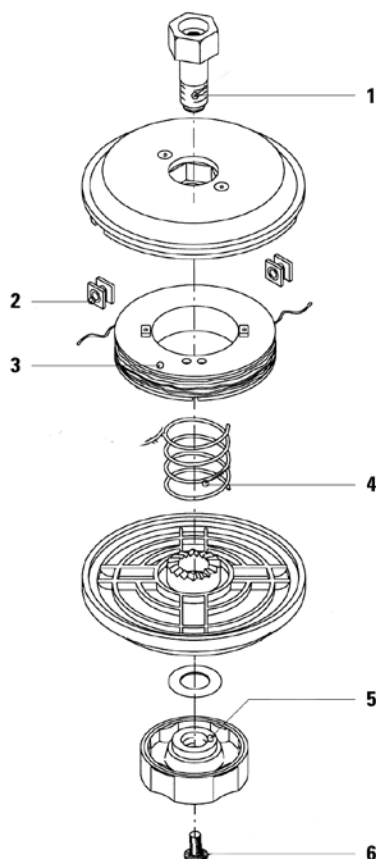

DESCRIPTION	P/N
<b>1</b> Adaptor M 7 x 1.00 Left male	<b>5030015</b>
Adaptor M 8 x 1.25 Left male	<b>5030018</b>
Adaptor M 8 x 1.25 Left male (fits EMAK only)	<b>5030044</b>
Adaptor M 8 x 1.25 Left female	<b>5030021</b>
Adaptor M 10 x 1.00 Left female (fits HU only)	<b>5030025</b>
Adaptor M 10 x 1.00 Left female (fits Stihl only)	<b>5030024</b>
Adaptor M 10 x 1.25 Left female	<b>5030027</b>
Adaptor M 10 x 1.25 Left male	<b>5030028</b>
Adaptor M 10 x 1.50 Left female	<b>5030029</b>
Adaptor M 12 x 1.50 Left female	<b>5030031</b>
Adaptor M 12 x 1.75 Left female	<b>5030032</b>
<b>2</b> Line retainer (square)	<b>5030011</b>
<b>3</b> Spool without line	<b>5030014</b>
Spool with line (6m)	<b>5030043</b>
<b>4</b> Spool spring	<b>5030010</b>
<b>5</b> Left knob	<b>5030009</b>
Right knob	<b>5030013</b>
<b>6</b> Knob screw	<b>5030012</b>

## Guide list for head adaptors

<b>ALKO</b>	LT250C	8 x 1.25 LHM
	MS400, 106146	10 x 1.25 LHF
	106389, 106144, 106436, 106145	8 x 1.25 LHF
<b>ARIMITSU</b>	ACC15, ACC17, ACD-17, ACD18, ACE30, ACZEK, AM-16D, AM-24, AM-24D, AM-31, AM-31K, AM-31KL, AM40, AM50	8 x 1.25 LHM
<b>ALPINA</b>	170, 180, 190, 200	8 x 1.25 LHM
	VIP21, VIP25, VIP30, VIP34, VIP34D, VIP34F, VIP42, VIP35F, VIP52, VIP52D, VIP52F, VIP42D, VIP42F	8 x 1.25 LHF
	210, 220	10 x 1.25 LHF
<b>BLUEBIRD</b>	SBC23E, 27E, NBC31EA, NBC38E, M47, M54	10 x 1.00 LHF
<b>DOLMAR</b>	BC250, LT250, BC330, BC400, SD330, BC250, PRO370, PRO400, MS3300/4000/4500	10 x 1.25 LHM
	BC337, BC377, NB26, NB03, NB04, NB31, NB40, MS3500, NB40, NB411, NB50, NB351, BD330, C250, LT-250	10 x 1.00 LHF
	BC225, C225, LT225, MS220, MS2300, MS2600, MS3100, LT154, NB, NB01F, NB02, NB16F, NB211, NBF171, NB26/31, LT225, LT255, NB2, NB271, MS-250, MS3200, MS5200, MS2810	8 x 1.25 LHF
	MS340, BC-12, BC-210, BC-212, MS5250, BC210, BC212, MS-30C, MS30U	10 x 1.25 LHF
	MS3300, MS4000, MS4500, MS3310, MS-4010, MS-4510	12 x 1.50 LHF
	NB231AU, NB231A, NB23F, NB171, LT250	8 x 1.25 RHF
<b>ECHO</b>	LT210	10 x 1.25 RHF
	SRM2300L, 2300U, SRM2090L, 2090U, SRM250EL, ARM400A, RM460, RMA2530, SRA2190, 250EU, SRM310, 310U, RM380, SRM302BDX, SRM3800, SRM4600, SRM2450L, 2450U, SRM3500, SRM3550, SRM2510, RM460, SRA2190, RMA2530, SRM2600L, 2600U, SRM3150L, 3150U, SRM343SL, CLS4600, GT2400, RM310, SRM2010L, 140, 160AE, 190, 200, 200BE, 250/EU, 300, 302, 310/U, 400, 402, 500, 501, 3150U, 3800, 4600, SRM300, RMA2530, SRM140DA, SRM1500, SRM1501, SRM200BE, SRM200-CE, SRM200DA, SRM200DB, SRM2010, SRM2200, SRM2201, SRM2301, SRM2500, SRM2501, SRM2502, SRM3000, SRM3001, SRM300AE, SRM300E, SRM3010, SRM400AE, SRM400BE, SRM402-DE, SRM3800, 2010, 2300, 2090, 2090U, 2510, 3500, 2190, 2530, SRM-2450L, 2500, 2501, 2502, 250EL, 2510, 2600L, 3010, SRM-2455, 2015, 2455, 315SL, 360, 2655, 400, 5000	10 x 1.25 LHF
	ST160AE, 500, 501, 210AE, 2300/U, 2450U, 2510, 2530, 2600U	10 x 1.25 RHF
	CLS4600, CLS5800, CLS5810	12 x 1.75 LHF
<b>EMAK</b>	200 Series -200, 2201C, 260/D, 2601C, 2601CVA, 261/A, 300 Series 300A/AIC, 301, 310, 350, 400 Series 400/AIC, 400A, 410, 450, 460/AVS, 8060, 8100, 8200, 8250R, STARK26TR	8 x 1.25 LHM
	8250RL, 8220IC, 8260IC, STARK26IC, 8250/IC/ICD, 8300NEW, 8250ICD, 8250ICNEW, 8350/IC, 8400/IC, 8460/IC, 8530/IC, 8550BOSS, 8355, 8405, 8465, 8535	8 x 1.25 LHF
	8250RL, 8220IC, 8260IC, STARK26IC, 8250/IC/ICD, 8300NEW, 8250ICD, 8250ICNEW, 8350/IC, 8400/IC, 8460/IC, 8530/IC, 8550BOSS, 8355, 8405, 8465, 8535	8 x 1.25 LHM
<b>HOMELITE</b>	TM523	7 x 1.00 LHM
	BCH - 20, 24 2D, 32C, 33, 33B, 33DI, 33TO	8 x 1.25 LHM
	HBC30, -30B, 38, 40, HK- 14, 18, 24, 28, 33, 38, PCB3600, 3600E, PLT3400, ST155, 175C, 185C, 285C, 385C, ST485, ST485C	8 x 1.25 LHF
	ST360, ST385, SXD20, TK518, NBA524, PMB522, TXD508	8 x 1.25 LHM
	BCH38, BCH40, BCH48, PBC3800, PBC4000	10 x 1.25 LHF
	NBA524, PMB522, TXD508	10 x 1.25 LHM
<b>HONDA</b>	UH41, SXD-25HE	8 x 1.25 LHM
	UMK422LTE/UT4E/LT4E	10 x 1.25 LHF
<b>HUSQVARNA</b>	24R (before 1987)	7 x 1.00 LHM
	265RX, 250RX, 245RX, 135R, 132RD, 132LD, 125R, 25R, 125RD, 125LD, 125RB, 132RL, 245R, 125L, 132L, 125RJ, 125RJD, 26R, 235R, 32L, 120L, 225L, 225LD, 227R	12 x 1.75 LHM
	232L, 232LCAT, 32R, 225RJ, 225R, RD, 232R, 232RCAT, 322L, 325LX/XT, 325RJX, 322RJ, 325RX/RXT	10 x 1.25 LHF
	235RCAT, 240R, 240RBD, 250RX, 245R, 245RX, 265RX, 140R, 165R, 244R, 244GX, 36R, 39R, 16R, 18RL, 22RL, 240RJ, 142RB, 152RB, 252RX	12 x 1.75 LHF
	Mondo MEGA, Mondo Maxi	3/8" x .24 LHF
	26L	3/8" x .24 RHF
	16R, 25R - before 1987	8 x 1.25 LHM

## Guide list for head adaptors

<b>ISEKI SHINDAIWA</b>	DYB251, DYB252, DYB254, DYB261, DYB262, DYB321, DYB322	8 x 1.25 LHM
	DYB351, DYB453, DYB354, DYB454	10 x 1.25 LHM
	DYB201, DYB202, DYB231, DYB232	7 x 1.00 LHM
	IAX180, 190, 250, 350, 400, 500	8 x 1.25 LHF
<b>JONSERED</b>	G25RD	8 x 1.25 LHF
	GR32L/CAT, GR44, GT21/22/24, RS44, BP2040C, GR3032D/L	10 x 1.25 LHF
	GR32D/CAT, GR36/CAT, GR41/50, R38/45, RS30/38/40/45, RS51PRO, RS52, GR2036, BP2052, BP240C	12 x 1.75 LHF
	G25RD	8 x 1.25 LHF
<b>KAAZ</b>	V20	7 x 1.00 LHM
	K10, K20, K2020, K2Q, K2Q20, K30, KLQ, KOP20B, KPQ/20, KQ, KQP20, KQT130, KT12, RQ20, U10, V15/18/25, VP15/20, VS220/230/250, VX230/260	8 x 1.25 LHF
	KQ20, V10	8 x 1.25 RHF
	410, J40/BD/HD, J400/GX, JLKT200, JLQT200, JQ/40/50, JQG4K, K40D/BD, KQ30/NE, KT10, KT18/1S/30, KW30NE, K40D/BD, KQ30/NE, KT10/18/1S/30, KW30NE, RQ30/40, RX350/351L, TI70,240/410, V190/35/40, V420/520, VNX540, VRX360/440/540, VX221/251C/360/360S, VX440	10 x 1.25 LHF
<b>MC CULLOCH</b>	BP30AV, DELTA, MS33/40, S'MAC30AV, TD2400/3300/4000	8 x 1.25 LHM
	MAC22/23/30/38	8 x 1.25 LHF
	MAC17/25	8 x 1.25 RHF
	100A, 90/A, 95A, 99A, EB3, MAC80/90/95A, PS1/2/3/4/5, SEB4, SM100, SMAC30AV, SMAV38AV	10 x 1.25 LHF
	TD2100, MAC32, MAC37	10 x 1.25 LHM
	MAC60A, MAC80A	10 x 1.25 RHF
	SUPERMAC26, MAC30A, 30AV, PRATER30, EUROPA92/35A, EUROPA, MS24, MS52, PROMAC38AV, BP38AV, WINDSORKIT26, VERSAILLES38, BP26AV, BP35AV	10 x 1.50 LHM
	MAC85A, MAC90A, MAC95A, SMAC30AV, SMAC38AV	10 x 1.25 LHF
<b>MAKITA</b>	RBC230, RBC260, RBC310, RBC410, RBK410, RBC525	8 x 1.25 LHM
	DBC3300, DBC4000, DBC4000C	12 x 1.50 LHF
<b>MARUNAKA</b>	BC180/181DX, BC200/240DX, TM2/21/24DX/F3L	8 x 1.25 LHF
	BT181DX	8 x 1.25 RHF
	G13K	10 x 1.25 LHF
	BC480DX, G3/5, GL3K, T240DX/F53/L	10 x 1.25 LHM
	TM33DX/F43L, TM33DX/F43, T200DX/F43L, T200DX/F43, TM33JX,/F404L, T200JX/F404L, BC330DX, BC400DX, BK404FX	10 x 1.50 LHF
<b>MARUYAMA</b>	BC184/C, BC220DE, BC230/241/326/330/402/480, BC331BK, MB100/250/300/400/500	8 x 1.25 LHM
	32, 35	10 x 1.25 LHM
	23	10 x 1.50 LHF
	BC200C, BC260/H, MC260/S	10 x 1.25 LHF
<b>OLEOMAC</b>	TR60E, TR101E, 720, SPARTA26TR, 725B,	8 x 1.25 LHF
	725BL, 722/726S, SPARTA26S, SPARTA26, 725S/T/D, 730S/T, 735S/T, 740S/T, 746S/T, 733S/T, 755MASTER, 435/440/446/453BP	8 x 1.25 LHM
<b>PARTNER</b>	B400	10 x 1.00 LHF
	200, 203, 205, B250C, B250V(before1987), T250, B323, B325	10 x 1.25 LHF
	B370, B380, B180, B440, B450, B405, B250C/V, B250U, B450G, B450/C, B265J, B405	12 x 1.75 LHF
	T221, T321, B322	8 x 1.00 LHF
<b>POULAN</b>	150, 200, 2620, 800, 900	10 x 1.50 LHF
<b>ROBIN</b>	NB30K, NBR30/40	8 x 1.25 LHM
	IVBK411, NB02, NB16F, NB211, NB26, NB281A, NB31/AU, NB351, NBA231, NBK411, NBT415, IVBF231, NB231, NB23F, NBF171, NBF231	8 x 1.25 LHF
	IVB50L, NB03/4, NB411L, NB50L	10 x 1.00 LHF



## Guide list for head adaptors

<b>RYOBI</b>	180KS/S, 3318, REK285BP	8 x 1.25 LHM
	RD1605, RD2414, RD3818	8 x 1.25 LHF
	RD5224, RD5225, RSB2801, RSH1100	10 x 1.25 LHM
	RD260	10 x 1.50 LHF
	RD330, RD430, RD520	12 x 1.75 LHF
<b>SHINDAIWA</b>	C20/230, LT18/20, T18/20/A, T230/XR, T23E, T35	7 x 1.00 LHM
	BP35/45, C23/25/27, C250, F20, R2025/35F, T25/27/250, T260/270/350, YARDWARE220	8 x 1.25 LHM
	B35/40/45, BP35, C35, RC35/45, F18	10 x 1.25 LHM
<b>STIHL</b>	FS50, FS51, FS60, FS61, FS65, FS80E, FS90AVE	8 x 1.25 LHM
	FS44, FS52, FS56, FS66, FS86, FR106, FS74, FS74R, FE55, FS36, FS88, FR108, FS40, FS76, FS76R, FS106, FS108, FS48, FS52, FS62, FS81, FS96,	10 x 1.00 LHF
	FS160, FS220, FS55/R, FS25-4/R, FS65-4/R, FS80R, FS85/R/RT	10 x 1.50 LHF
	420, FS08, FS150/180, FS20, FS200, FS280/K, FS353AV, FS360, FS410, FS420, FR350/450, FS350/450/400K/450K, FS400/L, FS500, FS550	12 x 1.50 LHF
<b>SOLO</b>	FS125, S200, S300	8 x 1.25 LHF
	123, 125, Multimot	10 x 1.00 LHF
	100, 130S, 014, 119, 400, FS135, FS136, S100, S400	10 x 1.25 LHF
	115, 118	10 x 1.25 RHF
	124, 126, 127, 128, 130, 134, 137, 140, 141	12 x 1.50 LHF
<b>TAS TANAKA</b>	AST250/5000/7000, SUM250, SUM301/321/321E/351/400, SUM421/500/7000, TBC16/160/162/20/2000, SUM205/215/220/2200, TBC225-255, TCB23/232/2507250DH/262/265/265SDH/262, TBC265, TBC265SDH/30/300/322/355/37/373/4000/422/422BDH, TBC4500/500/5000/500DH/501/202, TBC300SDH/355DH, TST218, TUM220, TUM250	8 x 1.25 LHM
	SUM3	10 x 1.25 LHF
	TBC16, AST5000, TBC5000, TBC4000	8 x 1.25 RHF
<b>ZENOAH</b>	BC220DL, BC221DL, BC17, BC23, BC32	7 x 1.00 LHM
	BC2300DL	8 x 1.00 LHF
	BC254A, BC260DM/DUM, BC260DM, BC340DWM/FW, BC341DWH, BC431DWM, BC432FWM, BCD20, BCF01, BK345FL, BK435FL, BK530DL	8 x 1.25 LHM
	BC431FWM, BC531DWM, BC532DWM, BK531DL, FBC22, FBC26	10 x 1.25 LHM

## Round nylon line

Quality ★★★★★



### ► Donuts 15 m

P/N	Ø mm	m	Q.ty per carton
<b>5200154</b>	1.3 (.050")	15	196 pcs.
<b>5200155</b>	1.6 (.065")	15	196 pcs.
<b>5200156</b>	2.0 (.080")	15	196 pcs.
<b>5200157</b>	2.4 (.095")	15	182 pcs.
<b>5200158</b>	2.7 (.105")	15	112 pcs.
<b>5200159</b>	3.0 (.119")	15	112 pcs.
<b>5200160</b>	3.3 (.130")	15	112 pcs.



### ► Donuts

P/N	Ø mm	m	Q.ty per carton
<b>5200179</b>	1.6 (.065")	97	72 pcs.
<b>5200180</b>	2.0 (.080")	63	72 pcs.
<b>5200181</b>	2.4 (.095")	44	72 pcs.
<b>5200182</b>	2.7 (.105")	36	72 pcs.

### ► Donuts

P/N	Ø mm	m	Q.ty per carton
<b>5200120</b>	1.6 (.065")	196	40 pcs.
<b>5200121</b>	2.0 (.080")	126	40 pcs.
<b>5200122</b>	2.4 (.095")	88	40 pcs.
<b>5200123</b>	2.7 (.105")	72	40 pcs.
<b>5200124</b>	3.0 (.119")	56	40 pcs.
<b>5200125</b>	3.3 (.130")	46	40 pcs.

## Round nylon line

Quality ★★★★★



### ► Spool 2 Pounds (0,904 Kg Approx.)

P/N	Ø mm	m
<b>5200111</b>	2.4 (.095")	175
<b>5200112</b>	2.7 (.105")	143
<b>5200113</b>	3.0 (.119")	112
<b>5200114</b>	3.3 (.130")	92

### ► Spool 3 Pounds (1,356 Kg Approx.)

P/N	Ø mm	m
<b>5200245</b>	2.4 (.095")	264
<b>5200246</b>	2.7 (.105")	216
<b>5200247</b>	3.3 (.130")	139

### ► Spool 4 Pounds (1,808 Kg Approx.)

P/N	Ø mm	m
<b>5200097</b>	2.0 (.080")	503
<b>5200098</b>	2.4 (.095")	349
<b>5200099</b>	2.7 (.105")	286
<b>5200100</b>	3.0 (.119")	223
<b>5200101</b>	3.3 (.130")	185

### ► Spool 5 Pounds (2,260 Kg Approx.)

P/N	Ø mm	m
<b>5200242</b>	2.4 (.095")	439
<b>5200243</b>	2.7 (.105")	360
<b>5200240</b>	3.0 (.119")	281
<b>5200244</b>	3.3 (.130")	232

### ► Spool 10 Kg Approx.

P/N	Ø mm	Length m (Approx.)
<b>5200134</b>	1.3 (.050")	6610
<b>5200135</b>	1.6 (.065")	4360
<b>5200086</b>	2.0 (.080")	2790
<b>5200087</b>	2.4 (.095")	1940
<b>5200088</b>	2.7 (.105")	1590
<b>5200089</b>	3.0 (.119")	1240
<b>5200090</b>	3.3 (.130")	1030

P.N. AND PRICES ARE REFERRED TO 1 KG



## Square nylon line

Quality ★★★★★



### ► Donuts 15 m

P/N	Ø mm	m	Q.ty per carton
<b>5200162</b>	2.4 (.095")	15	168 pcs.
<b>5200163</b>	2.7 (.105")	15	112 pcs.
<b>5200164</b>	3.0 (.119")	15	112 pcs.
<b>5200165</b>	3.3 (.130")	15	112 pcs.



### ► Donuts

P/N	Ø mm	m	Q.ty per carton
<b>5200186</b>	2.4 (.095")	34	72 pcs.
<b>5200187</b>	2.7 (.105")	28	72 pcs.
<b>5200188</b>	3.0 (.119")	22	72 pcs.
<b>5200189</b>	3.3 (.130")	18	72 pcs.

### ► Donuts

P/N	Ø mm	m	Q.ty per carton
<b>5200127</b>	2.4 (.095")	69	40 pcs.
<b>5200128</b>	2.7 (.105")	57	40 pcs.
<b>5200129</b>	3.0 (.119")	44	40 pcs.
<b>5200130</b>	3.3 (.130")	36	40 pcs.

## Square nylon line

Quality ★★★★★



### ► Spool 2 Pounds (0,904 Kg Approx.)

P/N	Ø mm	m
<b>5200139</b>	2.4 (.095")	137
<b>5200116</b>	2.7 (.105")	112
<b>5200140</b>	3.0 (.119")	88
<b>5200141</b>	3.3 (.130")	72

### ► Spool 3 Pounds (1,356 Kg Approx.)

P/N	Ø mm	m
<b>5200231</b>	2.4 (.095")	207
<b>5200250</b>	2.7 (.105")	170
<b>5200251</b>	3.0 (.119")	132
<b>5200252</b>	3.3 (.130")	109

### ► Spool 4 Pounds (1,808 Kg Approx.)

P/N	Ø mm	m
<b>5200103</b>	2.4 (.095")	274
<b>5200104</b>	2.7 (.105")	225
<b>5200105</b>	3.0 (.119")	175
<b>5200106</b>	3.3 (.130")	145

### ► Spool 5 Pounds (2,260 Kg Approx.)

P/N	Ø mm	m
<b>5200232</b>	2.4 (.095")	345
<b>5200248</b>	2.7 (.105")	283
<b>5200241</b>	3.0 (.119")	221
<b>5200249</b>	3.3 (.130")	182

### ► Spool 10 Kg Approx.

P/N	Ø mm	Length m (Approx.)
<b>5200092</b>	2.4 (.095")	1520
<b>5200093</b>	2.7 (.105")	1250
<b>5200094</b>	3.0 (.119")	970
<b>5200095</b>	3.3 (.130")	810

P.N. AND PRICES ARE REFERRED TO 1 KG



## Pro-trim disk Universal mounting



DESCRIPTION	P/N
PRO-TRIM UNIVERSAL "HOBBY" Ø 230 mm	<b>5025901</b>
PRO-TRIM UNIVERSAL Ø 300 mm	<b>5020937</b>

- ▶ Universal disk with three (3) nylon blades, universal mounting without adaptor, centering hole for both 20 ÷ 25.4 mm.

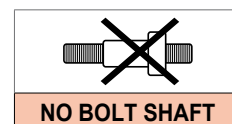

STANDARD PACKING	1 PC. PER BOX	
MASTER SHIPPER	40 UNITS	

## Pro-trim disk



DESCRIPTION	P/N
PRO-TRIM DISK WITHOUT ADAPTOR - CUTTING Ø 255 mm	<b>5020909</b>
PRO-TRIM DISK WITHOUT ADAPTOR - CUTTING Ø 300 mm	<b>5020919</b>

STANDARD PACKING	1 PC. PER BOX	
MASTER SHIPPER	40 UNITS	

## Spare parts

DESCRIPTION	P/N
<b>1</b> Nylon blade-short - L=67,5mm (cutting Ø230 mm)	<b>5020016</b>
Nylon blade-long - L=90mm (cutting Ø300 mm)	<b>5020017</b>
<b>2</b> Complete pin and nut	<b>5025011</b>
<b>3</b> Kit of adaptor washers and reduction rings	<b>K00401008</b>
<b>4</b> Adaptor M 8 x 1.25 Left male (fits EMAK only)	<b>100003002</b>
Adaptor M 8 x 1.25 Left female	<b>5070011</b>
Adaptor M 8 x 1.25 Left male	<b>5070020</b>
Adaptor M 8 x 1.25 Right male	<b>5070044</b>
Adaptor M 10 x 1.00 Left female (fits STIHL only)	<b>5070026</b>
Adaptor M 10 x 1.25 Left female	<b>5070008</b>
Adaptor M 10 x 1.25 Left female (fits HU only)	<b>5070024</b>
Adaptor M 10 x 1.25 Left male	<b>5070009</b>
Adaptor M 10 x 1.50 Left male (fits MC only)	<b>5070027</b>
Adaptor M 10 x 1.50 Left female (fits HU only)	<b>5070032</b>
Adaptor M 12 x 1.25 Left female (fits XENOAH only)	<b>100003001</b>
Adaptor M 12 x 1.50 Left female	<b>5070010</b>
Adaptor M 12 x 1.75 Left female (fits HU only)	<b>5070028</b>
Adaptor M 14 x 1.50 Left female (fits STIHL only)	<b>5070039</b>

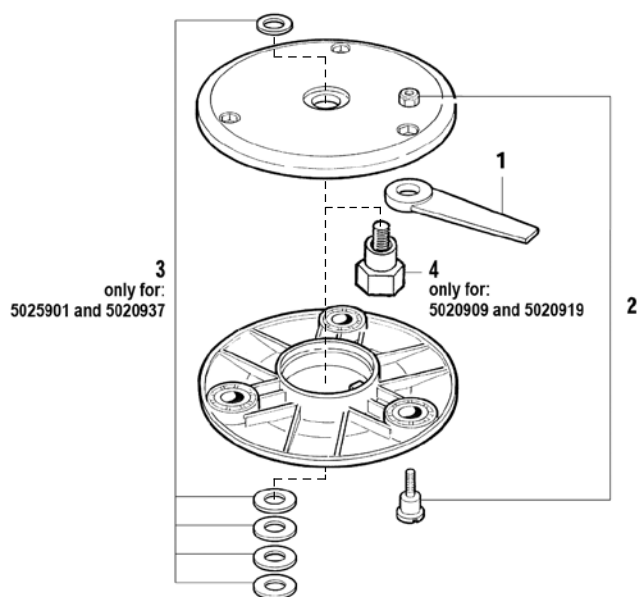

## Nylon blades



DESCRIPTION			P/N
OUTSIDE DIAM.	250 mm	9,8" inch.	<b>5010013</b>
HOLE DIAM.	25,4 mm	1" inch.	

► 3 Teeth-Nylon blade.

MASTER SHIPPER 40 PCS. PER BOX



DESCRIPTION			P/N
OUTSIDE DIAM.	230 mm	9" inch.	<b>5010004</b>
HOLE DIAM.	25,4 mm	1" inch.	
OUTSIDE DIAM.	255 mm	10" inch.	<b>5010005</b>
HOLE DIAM.	25,4 mm	1" inch.	

► 4 Teeth-Nylon blade.

MASTER SHIPPER 50 PCS. PER BOX



DESCRIPTION			P/N
OUTSIDE DIAM.	220 mm	9" inch.	<b>5010002</b>
HOLE DIAM.	25,4 mm	1" inch.	

► 8 Teeth-Nylon blade.

MASTER SHIPPER 50 PCS. PER BOX



## Steel blades



**NEW**

DESCRIPTION			P/N
OUTSIDE DIAM.	300 mm	11,8" inch.	<b>5001034</b>
HOLE DIAM.	20,0 mm	.78" inch.	
THICKNESS	3,0 mm		
OUTSIDE DIAM.	300 mm	11,8" inch.	<b>5001033</b>
HOLE DIAM.	25,4 mm	1" inch.	
THICKNESS	3,0 mm		

► 2 Teeth-Steel blade.

MASTER SHIPPER

50 PCS. PER BOX



DESCRIPTION			P/N
OUTSIDE DIAM.	255 mm	10" inch.	<b>5001002</b>
HOLE DIAM.	25,4 mm	1" inch.	
THICKNESS	1,6 mm		
OUTSIDE DIAM.	305 mm	12" inch.	<b>5001003</b>
HOLE DIAM.	25,4 mm	1" inch.	
THICKNESS	1,6 mm		

► 2 Teeth-Steel blade.

MASTER SHIPPER

100 PCS. PER BOX



**NEW**

DESCRIPTION			P/N
OUTSIDE DIAM.	250 mm	9.8" inch.	<b>05001008</b>
HOLE DIAM.	25,4 mm	1" inch.	
THICKNESS	2,0 mm		

► 3 Teeth-Steel blade.

MASTER SHIPPER

50 PCS. PER BOX





## Steel blades



DESCRIPTION			P/N
OUTSIDE DIAM.	230 mm	9" inch.	<b>5001004</b>
HOLE DIAM.	25,4 mm	1" inch.	
THICKNESS	1,4 mm		
OUTSIDE DIAM.	255 mm	10" inch.	<b>5001005</b>
HOLE DIAM.	25,4 mm	1" inch.	
THICKNESS	1,4 mm		

► 3 Teeth-Nylon blade.

MASTER SHIPPER

50 PCS. PER BOX



DESCRIPTION			P/N
OUTSIDE DIAM.	230 mm	9" inch.	<b>5001007</b>
HOLE DIAM.	25,4 mm	1" inch.	
THICKNESS	1,4 mm		
OUTSIDE DIAM.	255 mm	10" inch.	<b>5001008</b>
HOLE DIAM.	25,4 mm	1" inch.	
THICKNESS	1,4 mm		

► 4 Teeth-Nylon blade.

MASTER SHIPPER

50 PCS. PER BOX



DESCRIPTION			P/N
OUTSIDE DIAM.	230 mm	9" inch.	<b>5001010</b>
HOLE DIAM.	25,4 mm	1" inch.	
THICKNESS	1,4 mm		
OUTSIDE DIAM.	255 mm	10" inch.	<b>5001011</b>
HOLE DIAM.	25,4 mm	1" inch.	
THICKNESS	1,4 mm		
OUTSIDE DIAM.	230 mm	9" inch.	<b>5001037</b>
HOLE DIAM.	20 mm	.78" inch.	
THICKNESS	1,4 mm		
OUTSIDE DIAM.	255 mm	10" inch.	<b>5001038</b>
HOLE DIAM.	20 mm	.78" inch.	
THICKNESS	1,4 mm		

► 8 Teeth-Nylon blade.

MASTER SHIPPER

50 PCS. PER BOX



## Steel blades



DESCRIPTION			P/N
OUTSIDE DIAM.	305 mm	12" inch.	<b>5001029</b>
HOLE DIAM.	20 mm	.78" inch.	
THICKNESS	4,0 mm		

OUTSIDE DIAM.	305 mm	12" inch.	<b>5001028</b>
HOLE DIAM.	25,4 mm	1" inch.	
THICKNESS	3,0 mm		

► 2 Teeth-molching purpose bent blade.

MASTER SHIPPER

50 PCS. PER BOX



DESCRIPTION			P/N
OUTSIDE DIAM.	300 mm	11,8" inch.	<b>05001005</b>
HOLE DIAM.	20 mm	.78" inch.	
THICKNESS	3,0 mm		

OUTSIDE DIAM.	300 mm	11,8" inch.	<b>05001006</b>
HOLE DIAM.	25,4 mm	1" inch.	
THICKNESS	3,0 mm		

► 3 Teeth-molching purpose bent blade.

MASTER SHIPPER

40 PCS. PER BOX



DESCRIPTION			P/N
OUTSIDE DIAM.	255 mm	10" inch.	<b>5001022</b>
HOLE DIAM.	25,4 mm	1" inch.	
THICKNESS	3,0 mm		

OUTSIDE DIAM.	305 mm	12" inch.	<b>5001023</b>
HOLE DIAM.	25,4 mm	1" inch.	
THICKNESS	3,0 mm		

OUTSIDE DIAM.	305 mm	12" inch.	<b>5001030</b>
HOLE DIAM.	20 mm	.78" inch.	
THICKNESS	3,0 mm		

► 3 Teeth

MASTER SHIPPER

25 PCS. PER BOX



## Steel blades



DESCRIPTION			P/N
OUTSIDE DIAM.	300 mm	11.8" inch.	<b>05001009</b>
HOLE DIAM.	20 mm	.78" inch.	
THICKNESS	2,25 mm		
OUTSIDE DIAM.	300 mm	11.8" inch.	<b>05001010</b>
HOLE DIAM.	25,4 mm	1" inch.	
THICKNESS	2,25 mm		

► 3 teeth.

MASTER SHIPPER

25 PCS. PER BOX



DESCRIPTION			P/N
OUTSIDE DIAM.	255 mm	10" inch.	<b>05001011</b> <b>10 teeth</b>
HOLE DIAM.	25,4 mm	1" inch.	
THICKNESS	2,0 mm		
OUTSIDE DIAM.	255 mm	10" inch.	<b>05001012</b> <b>12 teeth</b>
HOLE DIAM.	25,4 mm	1" inch.	
THICKNESS	2,0 mm		

► 10 and 12 teeth.

MASTER SHIPPER

25 PCS. PER BOX



DESCRIPTION			P/N
OUTSIDE DIAM.	255 mm	10" inch.	<b>05001007</b>
HOLE DIAM.	25,4 mm	1" inch.	
THICKNESS	2,0 mm		

► 20 Teeth new design tooth profile blade for most efficient clearing operations reversible and thus highly cost competitive.

MASTER SHIPPER

35 PCS. PER BOX



## Steel blades



DESCRIPTION			P/N
OUTSIDE DIAM.	225 mm	9" inch.	<b>5001041</b>
HOLE DIAM.	20 mm	.78" inch.	
THICKNESS	1,8 mm		
OUTSIDE DIAM.	225 mm	9" inch.	<b>5001042</b>
HOLE DIAM.	25,4 mm	1" inch.	
THICKNESS	1,8 mm		

► 22 Teeth

MASTER SHIPPER

25 PCS. PER BOX



DESCRIPTION			P/N	
OUTSIDE DIAM.	22 teeth	200 mm	8" inch.	<b>05001000</b>
HOLE DIAM.		20 mm	.78" inch.	
THICKNESS		1,6 mm		
OUTSIDE DIAM.	22 teeth	200 mm	8" inch.	<b>05001001</b>
HOLE DIAM.		25,4 mm	1" inch.	
THICKNESS		1,6 mm		
OUTSIDE DIAM.	24 teeth	230 mm	9" inch.	<b>05001002</b>
HOLE DIAM.		20 mm	.78" inch	
THICKNESS		1,8 mm		
OUTSIDE DIAM.	24 teeth	230 mm	9" inch.	<b>05001003</b>
HOLE DIAM.		25,4 mm	1" inch	
THICKNESS		1,8 mm		
OUTSIDE DIAM.	26 teeth	250 mm	9.8" inch.	<b>5001035</b>
HOLE DIAM.		25,4 mm	1" inch	
THICKNESS		1,8 mm		
OUTSIDE DIAM.	26 teeth	250 mm	9.8" inch.	<b>5001036</b>
HOLE DIAM.		20 mm	.78" inch	
THICKNESS		1,8 mm		

► 22 / 24 / 26 Teeth

MASTER SHIPPER

25 PCS. PER BOX

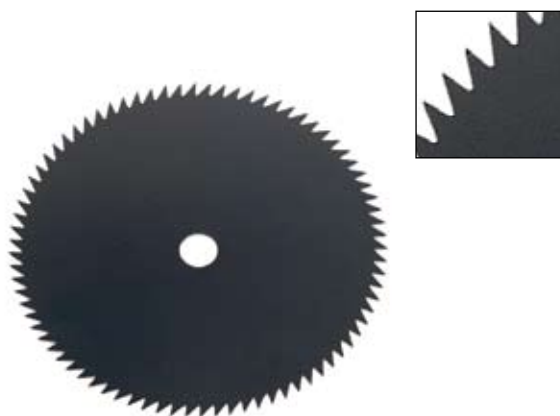

DESCRIPTION			P/N	
OUTSIDE DIAM.	60 teeth	230 mm	9" inch.	<b>5001039</b>
HOLE DIAM.		20 mm	.78" inch	
THICKNESS		1,4 mm		
OUTSIDE DIAM.	60 teeth	230 mm	9" inch.	<b>5001013</b>
HOLE DIAM.		25,4 mm	1" inch	
THICKNESS		1,4 mm		
OUTSIDE DIAM.	80 teeth	255 mm	10" inch.	<b>5001040</b>
HOLE DIAM.		20 mm	.78" inch	
THICKNESS		1,4 mm		
OUTSIDE DIAM.	80 teeth	255 mm	10" inch.	<b>5001014</b>
HOLE DIAM.		25,4 mm	1" inch	
THICKNESS		1,4 mm		

► 60 / 80 Teeth

MASTER SHIPPER

25 PCS. PER BOX



## Polycarbonate face shields

CE  
SCREEN EN 166-B  
MUFFS EN 352-1



### DESCRIPTION

"PRO" FACE SCREEN POLYCARBONATE SHIELD

Width: 450 mm  
Thickness: 0,8 ÷ 1 mm  
Height: 190 mm

### P/N

**5120916**

► Professional face screen with polycarbonate shield. Heavy duty adjustable face screen with ear muffs for professional demand. SNR: 30dB.

STANDARD PACKING

2 PCS. PER BOX



MASTER SHIPPER

16 PCS. PER BOX



### SPARE PARTS

**1093045** SCREEN POLYCARBONATE SHIELD

**1093073** KIT SCREW AND LOCK-RING

CE  
SCREEN EN 166-B



### DESCRIPTION

"PRO" FACE SCREEN

Width: 370 mm  
Height: 190 mm

### P/N

**5120913**

► Heavy duty type. Adjustable, with metal net shield. Highest safety and comfort. Extra large shield.

STANDARD PACKING

2 PCS. PER BOX



MASTER SHIPPER

12 PCS. PER BOX



### SPARE PARTS

**1093045** SCREEN POLYCARBONATE SHIELD

**1093073** KIT SCREW AND LOCK-RING



### DESCRIPTION

FACE SCREEN

Height: 190 mm  
Thickness: 0,8 ÷ 1 mm

### P/N

**5120903**

► Adjustable, with a spongy stripe.

STANDARD PACKING

8 PCS. PER BOX



MASTER SHIPPER

56 PCS. PER BOX



CE  
SCREEN EN 166-B



### DESCRIPTION

FACE SCREEN EXTRA-LIGHT

Height: 190 mm  
Thickness: 0,8 ÷ 1 mm

### P/N

**5120921**

► Adjustable, with a spongy stripe.

STANDARD PACKING

12 PCS. PER BOX



MASTER SHIPPER

72 PCS. PER BOX



## Metal net face shields



SCREEN EN 1731-S  
MUFFS EN 352-1

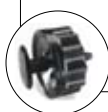

DESCRIPTION		P/N
"PRO" FACE SCREEN NET SHIELD	Width: 370 mm Height: 190 mm	<b>5120915</b>
▶ Professional face screen with metal net shield. Heavy duty adjustable face screen with ear muffs for professional demand. SNR: 30dB.		
STANDARD PACKING	2 PCS. PER BOX	
MASTER SHIPPER	16 PCS. PER BOX	
SPARE PARTS		
<b>1093046</b>	SCREEN NET SHIELD	
<b>1093073</b>	KIT SCREW AND LOCK-RING	



SCREEN EN 1731-S

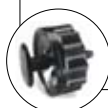

DESCRIPTION		P/N
"PRO" FACE SCREEN	Width: 370 mm Height: 190 mm	<b>5120912</b>
▶ Heavy duty type. Adjustable, with metal net shield. Highest safety and comfort. Extra large shield.		
STANDARD PACKING	2 PCS. PER BOX	
MASTER SHIPPER	12 PCS. PER BOX	
SPARE PARTS		
<b>1093046</b>	SCREEN NET SHIELD	
<b>1093073</b>	KIT SCREW AND LOCK-RING	



SCREEN EN 1731-S



DESCRIPTION		P/N
FACE SCREEN	Height: 190 mm	<b>5120901</b>
▶ Adjustable, with a spongy stripe. Metal net shield.		
STANDARD PACKING	8 PCS. PER BOX	
MASTER SHIPPER	56 PCS. PER BOX	



DESCRIPTION		P/N
FACE SCREEN EXTRA-LIGHT	Height: 190 mm	<b>5120922</b>
▶ Adjustable, with a spongy stripe. Metal net shield.		
STANDARD PACKING	12 PCS. PER BOX	
MASTER SHIPPER	72 PCS. PER BOX	

## Ear muffs

CE  
MUFFS EN 352-1



STANDARD PACKING:  
NYLON BAG - 1PC.  
MASTER SHIPPER50  
10 PCS. PER BOX



DESCRIPTION	P/N
-------------	-----

EAR MUFFS	<b>5135902</b>
-----------	----------------

► CE approved ear muffs. SNR: 30 dB.

CE  
MUFFS EN 352-1



STANDARD PACKING:  
NYLON BAG - 1PC.  
MASTER SHIPPER50  
10 PCS. PER BOX



DESCRIPTION	P/N
-------------	-----

EAR MUFFS	<b>5135901</b>
-----------	----------------

► CE approved ear muffs. SNR: 24 dB.

CE  
SCREEN EN 166-B



STANDARD PACKING:  
NYLON BAG - 1PC.  
MASTER SHIPPER50  
10 PCS. PER BOX



DESCRIPTION	P/N
-------------	-----

WHIT NON FOGGING LENSES	<b>5130901</b>
-------------------------	----------------

► CE approved goggles.

CE  
SCREEN EN 1731-3



STANDARD PACKING:  
NYLON BAG - 1PC.  
MASTER SHIPPER50  
10 PCS. PER BOX



DESCRIPTION	P/N
-------------	-----

WHIT NYLON MESH LENSES	<b>5130902</b>
------------------------	----------------

► CE approved goggles.

## Safety helmet

CE  
HELMET EN 397  
SCREEN EN 166 and EN 1731  
MUFFS EN EN 352-3



DESCRIPTION	P/N
-------------	-----

CE LOGGER'S HELMET ASSEMBLY	<b>51209001</b>
-----------------------------	-----------------

- For the professional users, comfortable and complete with EN approved ear and face protection sets.
- Safety helmet complies with 89/686/EEC, BS EN 397:1995
  - Face protection complies with EN166 and EN 1731
  - Ear Muffs comply with EN 352-3

STANDARD PACKING	1 PC. PER BOX	
------------------	---------------	--

MASTER SHIPPER	12 UNITS	
----------------	----------	--



SPARE PARTS		
-------------	--	--

1	<b>S00404000</b> NET SHIELD SUPPORT	20 PCS.
2	<b>S00901000</b> SCREEN NET SHIELD	20 PCS.
3	<b>C03100000</b> EAR MUFFS	20 PCS.

## Brushcutter shoulder straps



DESCRIPTION	P/N
SINGLE SHOULDER STRAP	<b>5150901</b>

► Simple and comfortable strap.

STANDARD PACKING NYLON BAG - 1PC. 

MASTER SHIPPER 50 PCS. PER BOX 



DESCRIPTION	P/N
COMFORT	<b>5150902</b>

► Double shoulder strap with waist pad.

STANDARD PACKING NYLON BAG - 1PC. 

MASTER SHIPPER 25 PCS. PER BOX 



DESCRIPTION	P/N
COMFORT PLUS	<b>5150903</b>

► Double shoulder strap with waist pad. Safety quick release.

STANDARD PACKING NYLON BAG - 1PC. 

MASTER SHIPPER 20 PCS. PER BOX 



DESCRIPTION	P/N
SUPER COMFORT	<b>5150904</b>

► Super comfort strap with waist pad. Safety quick release.

STANDARD PACKING NYLON BAG - 1PC. 

MASTER SHIPPER 5 PCS. PER BOX 



## Blade guards



DESCRIPTION	P/N
Cut diameter 380 mm Universal mounting To fit shaft: Ø24mm Ø26 mm / Ø28 mm	<b>51109001</b>
Cut diameter 420 mm Universal mounting To fit shaft: Ø24mm Ø26 mm / Ø28 mm	<b>51109000</b>

- ▶ Universal plastic blade guard for Nylon heads and Nylon or Steel Blades.
  - Mounting kit for shaft arms Ø 24 - 26 – 28 mm included.
  - Metallic mounting clamps assure a perfect and durable fixing performance.
- Easy and handy assembling.  
Removable lower plastic guard allows the right blade usage.

STANDARD PACKING

NYLON BAG - 1PC.



MASTER SHIPPER

40 PCS. PER BOX

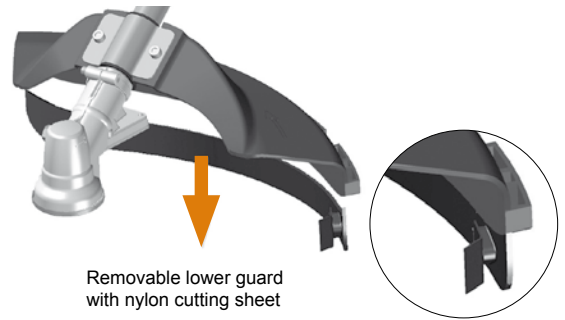

DESCRIPTION	P/N
BLADE GUARD - NYLON	<b>5110901</b>

- ▶ Blade guard, nylon. To fit shaft Ø 24 - Ø 26 - Ø 28 mm Standard.

STANDARD PACKING

NYLON BAG - 1PC.



MASTER SHIPPER

50 PCS. PER BOX



DESCRIPTION	P/N
BLADE GUARD - METAL SUPER	<b>5100902</b>

- ▶ Blade guard, metal super. To fit shaft Ø 24 - Ø 26 - Ø 28 mm.

STANDARD PACKING

NYLON BAG - 1PC.



MASTER SHIPPER

30 PCS. PER BOX



## Blade guards



### DESCRIPTION

P/N

BLADE GUARD - METAL

**5100901**

- ▶ Blade guard, metal. With adjustable rubber protection, best performance when using the nylon heads.

STANDARD PACKING

NYLON BAG - 1PC.



MASTER SHIPPER

20 PCS. PER BOX



## Shin Guards For hobbyists and professionals

**NEW**

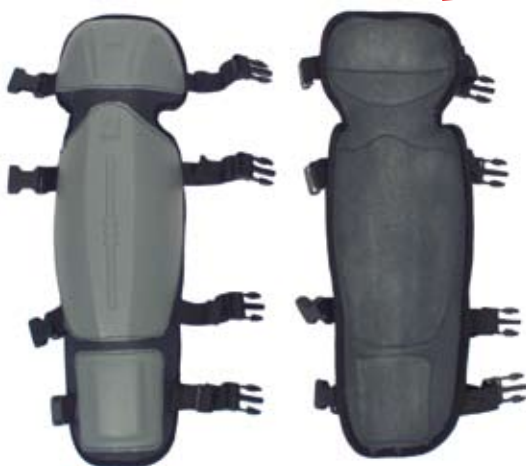

### DESCRIPTION

P/N

SHIN GUARDS

**51809000**

- ▶ Designed to protect legs from knee down to ankle. Their components and production make them light, comfortable, easy-on, easy-off and at the same time strong and shock-resistant.

STANDARD PACKING

NYLON BAG - 2PC.



MASTER SHIPPER

10 PAIRS PER BOX



## Blade supports



1



2

### DESCRIPTION

P/N

1 BORE 8 mm

**5250001**

1 BORE 10 mm

**5250002**

2 BORE 12 mm

**5250003**

2 BORE 14 mm

**5250004**

- ▶ Blade support, metal, fix.

STANDARD PACKING

NYLON BAG - 1PC.



MASTER SHIPPER

10 PCS. PER BOX



## Plastic cans



DESCRIPTION	P/N
CAN L 5 + 2,5 - PROFESSIONAL TYPE	<b>5170901</b>

► Double use plastic can, red. High quality, light and resistant.

STANDARD PACKING	4 PCS. PER BOX	
------------------	----------------	---

DESCRIPTION	P/N
COMPLETE SPOUT	<b>5170001</b>
COMPLETE CAP	<b>5170003</b>

STANDARD PACKING	4 PCS. PER BOX	
------------------	----------------	---



DESCRIPTION	P/N
CAN L 5 + 2,5 - PROFESSIONAL TYPE	<b>5170903</b>

► Double use plastic can, white. High quality, light and resistant.

STANDARD PACKING	4 PCS. PER BOX	
------------------	----------------	---

DESCRIPTION	P/N
COMPLETE SPOUT	<b>5170001</b>
COMPLETE CAP	<b>5170003</b>

STANDARD PACKING	4 PCS. PER BOX	
------------------	----------------	---

## Plastic cans



DESCRIPTION	P/N
CAN L 5 STANDARD PACKING: NYLON BAG - 24 PCS. Q.ty PER PALLET: 240 PCS	<b>51709001</b>
CAN L 10 STANDARD PACKING: NYLON BAG - 14 PCS. Q.ty PER PALLET: 98 PCS	<b>51709002</b>

► Fuel Cans of best quality, delivered complete with flexible spout, handy and useful for professional and private users.



DESCRIPTION	P/N
COMPLETE SPOUT	<b>K00404001</b>
COMPLETE CAP	<b>K00404000</b>
STANDARD PACKING	4 PCS. PER BOX 



DESCRIPTION	P/N
CAN L 3,650 + 1,450	<b>5170902</b>
► Double use plastic can, red.	
STANDARD PACKING	14 PCS. PER BOX 

## AUTO FILL STOP self-closing spout

**NEW**



### DESCRIPTION

P/N

Funnel self-closing spout

**5170906**

- ▶ Spout for cans with blocking system in the case of fuel leakage.
  - Easy to fit on Tecomec cans.
  - Guarantees correct filling without liquid spillage.
  - Suitable for all tanks used by major manufacturers of gardening machinery.

STANDARD PACKING

NYLON BAG - 1PC.



MASTER SHIPPER

20 PCS. PER BOX



> Suitable for use on Tecomec dual-purpose cans: P/N 5170901, P/N 5170902 and P/N 5170903.



> End pull-out part. When pulled-out, the liquid flows out; when it is in the normal position, the liquid does not flow out.



> The cap can also be put at the top to protect it against impact and dirt.

## Funnel assy filter



### DESCRIPTION

P/N

**1** FUNNEL ASSY - SMALL

**5175901**

**2** FUNNEL ASSY - MEDIUM

**5175902**

**3** FUNNEL FILTER

**5175001**

STANDARD PACKING

24 PCS. PER BOX







CHAIN SAW SPARE PARTS

Precision Tooling  
ITALY

Cylinder assy - Piston assy .....	64
Piston rings .....	67
Sprocket rim .....	67
Crankshafts .....	68
Vibration dampings .....	68
Air filters .....	69
Fuel filters .....	72
Fuel Caps .....	74
Oil Caps .....	74
Starter rope .....	74
Pulleys .....	75
Pawls .....	75
Metal rings - Plastic rings .....	75
Gasket sets .....	76
Exhausts .....	76
Starter handles .....	77
Starter handles .....	78
Spark plugs .....	78
Chain tighteners .....	79
Tube handles .....	79
Nuts .....	79
Ignition coils .....	80
Spark plug terminals .....	80
Insulated cable .....	80
Switches .....	81
Wrenches .....	81



## Packaging & Shipment

### Type of packaging

	Carton box
	Plastic clamshell / Blister
	Nylon bag

### Type of shipment and minimum q.ty per order

	Carton master shipper
---	-----------------------



Suitable for the following chain saws:

## Cylinder assy - Piston assy



MAKE FITS	DESCRIPTION	SEL:	P/N	O.E.M. Ref
HUSQVARNA 254-254XP	Cylinder assy ø 45 mm		<b>88570264</b>	503 50 39-02
	Piston assy	<b>B</b>	<b>88572507</b>	503 50 37-01
	Piston ring		<b>574161</b>	503 28 90-11

STANDARD PACKAGING:

1 SET PER BOX



MAKE FITS	DESCRIPTION	SEL:	P/N	O.E.M. Ref
HUSQVARNA 61	Cylinder assy ø 48 mm		<b>88570252</b>	503 53 20-71
	Piston assy	<b>B</b>	<b>88572499</b>	503 53 90-02
	Piston ring		<b>574157</b>	503 28 90-15

STANDARD PACKAGING:

1 SET PER BOX



MAKE FITS	DESCRIPTION	SEL:	P/N	O.E.M. Ref
HUSQVARNA 268-268S-268K	Cylinder assy ø 50 mm		<b>88570280</b>	501 65 85-71
	Piston assy	<b>B</b>	<b>88572524</b>	501 65 94-03
	Piston ring		<b>574142</b>	503 28 90 17

STANDARD PACKAGING:

1 SET PER BOX



MAKE FITS	DESCRIPTION	SEL:	P/N	O.E.M. Ref
HUSQVARNA 65-265	Cylinder assy ø 48 mm		<b>88570282</b>	50 14 178-01
	Piston assy	<b>B</b>	<b>88572526</b>	50 12 056-03
	Piston ring		<b>574157</b>	50 12 059-02

STANDARD PACKAGING:

1 SET PER BOX



Suitable for the following chain saws:

## Cylinder assy - Piston assy



MAKE FITS	DESCRIPTION	SEL:	P/N	O.E.M. Ref
PARTNER K650 ACTIVE	Cylinder assy ø 50 mm		<b>88570268</b>	506 09 92-12
	Piston assy	<b>B</b>	<b>88572511</b>	506 09 90-01
	Piston ring		<b>574137</b>	503 28 90-17
	De-Compression Valve		<b>576118</b>	503 71 53-01

STANDARD PACKAGING:

1 SET PER BOX



MAKE FITS	DESCRIPTION	SEL:	P/N	O.E.M. Ref
STIHL 026	Cylinder assy ø 44 mm		<b>88570281</b>	1121 020 1208
	Piston assy	<b>B</b>	<b>88572525</b>	1121 030 2001
	Piston ring		<b>574170</b>	1121 034 3010

STANDARD PACKAGING:

1 SET PER BOX



MAKE FITS	DESCRIPTION	SEL:	P/N	O.E.M. Ref
STIHL 028 SUPER	Cylinder assy ø 46 mm		<b>88570216</b>	1118 020 1202
	Piston assy	<b>B</b>	<b>88572449</b>	1118 030 2003
	Piston ring		<b>574144</b>	1118 034 3001

STANDARD PACKAGING:

1 SET PER BOX



MAKE FITS	DESCRIPTION	SEL:	P/N	O.E.M. Ref
STIHL 034-036	Cylinder assy ø 48 mm		<b>88570250</b>	1125 020 1213
	Piston assy	<b>B</b>	<b>88572497</b>	1125 030 2001
	Piston ring		<b>574158</b>	1125 034 3001

STANDARD PACKAGING:

1 SET PER BOX



Suitable for the following chain saws:

## Cylinder assy - Piston assy



MAKE FITS	DESCRIPTION	SEL:	P/N	O.E.M. Ref
STIHL	Cylinder assy $\varnothing$ 52 mm		<b>88570272</b>	1119 020 1202
038 MAGNUM	Piston assy	<b>B</b>	<b>88572515</b>	1119 030 2002
	Piston ring		<b>574106</b>	1115 034 3010

STANDARD PACKAGING:

1 SET PER BOX



MAKE FITS	DESCRIPTION	SEL:	P/N	O.E.M. Ref
STIHL	Cylinder assy $\varnothing$ 52 mm		<b>88570162</b>	1111 020 1200
051-TS510	Piston assy	<b>B</b>	<b>88572261</b>	1111 030 2000
	Piston ring		<b>574106</b>	1115 034 3001

STANDARD PACKAGING:

1 SET PER BOX



MAKE FITS	DESCRIPTION	SEL:	P/N	O.E.M. Ref
STIHL	Cylinder assy $\varnothing$ 47 mm		<b>88570155</b>	1108 020 1220
08-TS350	Piston assy	<b>B</b>	<b>88572247</b>	1108 030 2020
	Piston ring		<b>574119</b>	1108 034 3001

STANDARD PACKAGING:

1 SET PER BOX



MAKE FITS	DESCRIPTION	SEL:	P/N	O.E.M. Ref
STIHL	Cylinder assy $\varnothing$ 49 mm		<b>88570227</b>	4201 020 1200
08S-TS360	Piston assy	<b>B</b>	<b>88572460</b>	4201 030 2000
	Piston ring		<b>574143</b>	4201 034 3000

STANDARD PACKAGING:

1 SET PER BOX



## Cylinder assy - Piston assy

Suitable for the following chain saws:



MAKE FITS	DESCRIPTION	SEL:	P/N	O.E.M. Ref
STIHL TS400	Cylinder assy ø 49 mm		<b>88570277</b>	4223 020 1200
	Piston assy	<b>B</b>	<b>88572521</b>	4223 030 2000
	Piston ring		<b>574143</b>	1127 034 3006

STANDARD PACKAGING:

1 SET PER BOX



## Piston rings

Suitable for the following chain saws:



MAKE	FITS	Ø mm	P/N	O.E.M. Ref
DOLMAR	123-309	47	<b>574119</b>	123 132 020
HUSQVARNA	254-254XP	45	<b>574161</b>	503 28 90-11
	61	48	<b>574157</b>	503 28 90-15
	266-266XP	50	<b>574142</b>	501 69 98-01
	268-268S-268K	50	<b>574142</b>	503 28 90-17
	65-265	48	<b>574157</b>	5012 059-02
PARTNER	K650 ACTIVE	50	<b>574137</b>	503 28 90-17
STIHL	026	44	<b>574170</b>	1121 034 3010
	028 SUPER	46	<b>574144</b>	1118 034 3001
	034-036	48	<b>574158</b>	1125 034 3001
	038 MAGNUM	52	<b>574106</b>	1115 034 3010
	051-TS510	52	<b>574106</b>	1115 034 3001
	08S-TS350	47	<b>574119</b>	1108 034 3001
	TS360	49	<b>574143</b>	4201 034 3000
	TS400	49	<b>574143</b>	1127 034 3003

STANDARD PACKAGING: 10 PCS. PER CLAMSHELL



ORDER IN MULTIPLES OF (10)

## Sprocket rim

Suitable for the following chain saws:



**NEW**

SPROCKET RIM			OUR. REF.
SPLINE	PITCH	TEETH	
SMALL 7	3/8"	7	<b>00770 444</b>
STANDARD 7	3/8"	7	<b>00770 555</b>
STANDARD 8	3/8"	8	<b>00770 777</b>
STANDARD 7	.404"	7	<b>770 666</b>

STANDARD PACKAGING:

10 SET PER BOX



## Crankshafts

Suitable for the following chain saws:



MAKE FITS	DESCRIPTION	P/N	O.E.M. Ref
DOLMAR	123-309	<b>88590143</b>	123 120 002
HUSQVARNA	61-268-272(AFTER 93)	<b>88590165</b>	503 61 3371
PARTNER	K650 ACTIVE (New)	<b>88590200</b>	503 15 80-01
STIHL	051-075	<b>88590119</b>	1111 030 0402
	038-038 SUPER 038 MAGNUM	<b>88590150</b>	1119 030 0400
	08-08S-TS350-TS360	<b>88590116</b>	1108 030 042
	TS400	<b>88590156</b>	4223 030 0400

STANDARD PACKAGING:

1 PC. PER BOX



ORDER IN MULTIPLES OF (10)

## Vibration dampings

Suitable for the following chain saws:



MAKE FITS	DESCRIPTION	P/N	O.E.M. Ref
HUSQVARNA	480-61-162 Metal Crankcase	<b>657122</b>	50 12 763-01
	61-162 Metal Crankcase	<b>657123</b>	50 15 305-01
	266 Plastic Crankcase	<b>657132</b>	501 69 94-01
	266 Plastic Crankcase	<b>657133</b>	501 62 87-01
STIHL	028-038 Series	<b>657134</b>	1118 790 9930
	038 Series	<b>657135</b>	1121 790 9912
	028-038 Series	<b>657136</b>	1121 790 9909
	051 AV Back Handle	<b>657140</b>	1111 790 9915
	051 AV Back Handle (Down)	<b>657141</b>	1111 790 9905
	051 AV Front Handle (Up)	<b>657142</b>	1111 790 9900

STANDARD PACKAGING:

10 PCS. PER NYLON BAG



ORDER IN MULTIPLES OF (10)

## Air filters

Suitable for the following chain saws:

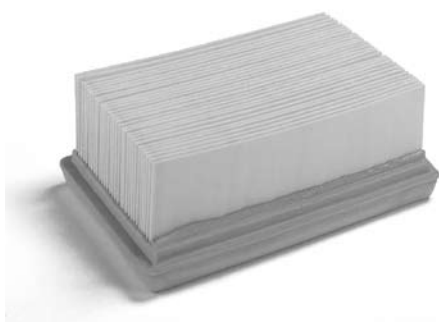

DOLMAR	OUR REF.
PC 62 12-PC 62 14	<b>540355</b>
O.E.M. part No. 394 173/010	
STANDARD PACKAGING:	5 PCS. PER NYLON BAG 
ORDER IN MULTIPLES OF (5)	



HUSQVARNA	OUR REF.
61-66-266-281-288	<b>540173</b>
O.E.M. part No. 501 80 71 01	
STANDARD PACKAGING:	5 PCS. PER NYLON BAG 
ORDER IN MULTIPLES OF (5)	



PARTNER	OUR REF.
R16-S50-S55-P55-P70	<b>540127</b>
O.E.M. part No. 315475	
STANDARD PACKAGING:	5 PCS. PER NYLON BAG 
ORDER IN MULTIPLES OF (5)	



PARTNER	OUR REF.
K650 (Pre-filter)	<b>540273</b>
O.E.M. part No. 505 315 545	
STANDARD PACKAGING:	5 PCS. PER NYLON BAG 
ORDER IN MULTIPLES OF (5)	

## Air filters

Suitable for the following chain saws:



STIHL	OUR REF.
-------	----------

038 - 038 Magnum	<b>540172</b>
------------------	---------------

O.E.M. part No. 1119 120 1610

STANDARD PACKAGING: 5 PCS. PER NYLON BAG



ORDER IN MULTIPLES OF (5)



STIHL	OUR REF.
-------	----------

051	<b>540136</b>
-----	---------------

O.E.M. part No. 1111 120 1601

STANDARD PACKAGING: 5 PCS. PER NYLON BAG



ORDER IN MULTIPLES OF (5)

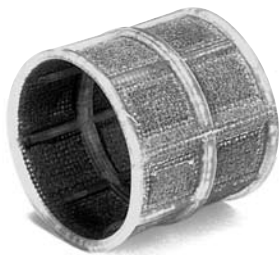

STIHL	OUR REF.
-------	----------

08	<b>540134</b>
----	---------------

O.E.M. part No. 1108 120 1600

STANDARD PACKAGING: 5 PCS. PER NYLON BAG



ORDER IN MULTIPLES OF (5)



STIHL	OUR REF.
-------	----------

TS 350-510	<b>540133</b>
------------	---------------

O.E.M. part No. 4201 140 1801

STANDARD PACKAGING: 5 PCS. PER NYLON BAG



ORDER IN MULTIPLES OF (5)

Suitable for the following chain saws:

## Air filters



STIHL	OUR REF.
TS 360	<b>540174</b>
O.E.M. part No. 4201 140 1802	
STANDARD PACKAGING:	5 PCS. PER NYLON BAG 
ORDER IN MULTIPLES OF (5)	



STIHL	OUR REF.
TS 350-360-510 (Pre filter)	<b>540238</b>
O.E.M. part No. 4201 141 0310	
STANDARD PACKAGING:	5 PCS. PER NYLON BAG 
ORDER IN MULTIPLES OF (5)	



STIHL	OUR REF.
TS 400	<b>540332</b>
O.E.M. part No. 4223 140 0300	
STANDARD PACKAGING:	5 PCS. PER NYLON BAG 
ORDER IN MULTIPLES OF (5)	



STIHL	OUR REF.
TS 400	<b>540336</b>
O.E.M. part No. 4223 141 0300	
STANDARD PACKAGING:	5 PCS. PER NYLON BAG 
ORDER IN MULTIPLES OF (5)	



## Air filters

Suitable for the following chain saws:



STIHL	OUR REF.
TS 400	<b>540337</b>
O.E.M. part No. 4223 141 0600	
STANDARD PACKAGING:	5 PCS. PER NYLON BAG 
ORDER IN MULTIPLES OF (5)	

## Fuel filters

Suitable for the following chain saws:



FUEL FILTER "POREX" (HU Type)	OUR REF.
Small "POREX"	<b>524103</b>
POREX only	<b>524104</b>
STANDARD PACKAGING:	10 PCS. PER NYLON BAG 
ORDER IN MULTIPLES OF (10)	



FUEL FILTER ASSY (HU Type)	OUR REF.
Small FELT	<b>524901</b>
FELT Only	<b>524900</b>
STANDARD PACKAGING:	10 PCS. PER NYLON BAG 
ORDER IN MULTIPLES OF (10)	



FUEL FILTER ASSY (HS Type)	OUR REF.
Large FELT	<b>524101</b>
FELT Only	<b>524102</b>
STANDARD PACKAGING:	10 PCS. PER NYLON BAG 
ORDER IN MULTIPLES OF (10)	

## Fuel filters

Suitable for the following chain saws:



### SUPER TYPE with inside sintered element

OUR REF.

FUEL FILTER ASSY (standard fitting)

**524123**

FUEL FILTER ASSY (suitable for Stihl)

**524133**

STANDARD PACKAGING: 10 PCS. PER NYLON BAG



ORDER IN MULTIPLES OF (10)



### FUEL FILTERS "POREX"

OUR REF.

ø 5 mm (suitable for HUSQVARNA)

**524148**

ø 5,7 mm (suitable for TILLOTSON)

**524154**

ø 8,5 mm (suitable for STIHL)

**524155**

STANDARD PACKAGING: 10 PCS. PER NYLON BAG



ORDER IN MULTIPLES OF (10)



### RUBBER FUEL LINE

OUR REF.

ø i 3,2 mm

**524106**

ø i 4,5 mm

**524107**

STANDARD PACKAGING: 5 m PER NYLON BAG



5 m per reel - the price is per 1 m

## Fuel Caps

Suitable for the following chain saws:

MAKE FITS	DESCRIPTION	P/N	O.E.M. Ref
HUSQVARNA	36-41-42-50-55-154-254 262-281-288-394-3120	<b>550151</b>	501 81 96 02
	234-238	<b>550151</b>	501 81 96-01
	65-77 (New)-380-480	<b>551107</b>	501 56 45-01
	61-66-266-268-272-2101	<b>551107</b>	501 43 14 02
	181	<b>550151</b>	501 81 96-01
JONSERED	625-630-631-670	<b>551107</b>	5015 645-01
STIHL	044	<b>550145</b>	1117 350 0500
	024-028-034-038-042-048	<b>550145</b>	1117 350 0500
	08	<b>550121</b>	1107 350 0500

STANDARD PACKAGING: 10 PCS. PER NYLON BAG



ORDER IN MULTIPLES OF (10)

## Oil Caps

Suitable for the following chain saws:

MAKE FITS	DESCRIPTION	P/N	O.E.M. Ref
HUSQVARNA	36-41-42-50-55-154-254-262	<b>551153</b>	501 76 56 02
	234-238	<b>551145</b>	501 62 66-01
	281-288-394	<b>550151</b>	501 81 96 02
	42-61-66-242-266-268-272	<b>551145</b>	501 62 66 02
	181	<b>550151</b>	501 81 96-01
STIHL	044	<b>550145</b>	1117 350 0500
	024-028-034-038-042-048	<b>551149</b>	1117 640 3600
	064-084	<b>550145</b>	1117 350 0500
	032	<b>551149</b>	1117 640 3600

STANDARD PACKAGING: 10 PCS. PER NYLON BAG



ORDER IN MULTIPLES OF (10)

## Starter rope

Suitable for the following chain saws:



DESCRIPTION	P/N
Spool Ø 3 x 100 m	<b>560125</b>
Spool Ø 3,5 x 100 m	<b>560126</b>
Spool Ø 4 x 100 m	<b>560127</b>
Spool Ø 4,5 x 100 m	<b>560128</b>

The price is per 100 m spool

## Pulleys

Suitable for the following chain saws:



MAKE FITS	DESCRIPTION	P/N	O.E.M. Ref
HUSQVARNA	266-66-181 (Bore ø 10)	<b>560182</b>	501 52 07-01
	266-66-181 (Bore ø 14)	<b>560211</b>	503 10 24-02
	268-272 (Bore ø 14 Hub Long)	<b>560253</b>	503 10 24 03
STIHL	036-044	<b>560237</b>	1128 195 0400
	08	<b>560146</b>	1107 190 1000
	038-041-042-045-048-051-056 08-075-TS350 (Metal)	<b>560224</b>	1117 195 0402
	034-024 (Nylon)	<b>560201</b>	1125 195 0401
	08-051-064-066 (Nylon)	<b>560200</b>	1122 195 0400

STANDARD PACKAGING: 5 PCS. PER NYLON BAG



ORDER IN MULTIPLES OF (5)

## Pawls

Suitable for the following chain saws:



MAKE FITS	DESCRIPTION	P/N	O.E.M. Ref
STIHL	009-010-011-024 028 (Old Model)-032	<b>560111</b>	1118 195 7200
	08-038-042-048-051-056 (Old Mod)	<b>560170</b>	1117 195 7200
	Pawl Spring	<b>560179</b>	1117 195 3500
	08-038-051-056-064-066-076- 084-TS360	<b>560202</b>	1124 195 7200
	009-010-011-012-021-023-024-025- 026-028-034-036-044	<b>560203</b>	1125 195 7200

STANDARD PACKAGING: 10 PCS. PER NYLON BAG



ORDER IN MULTIPLES OF (10)

## Metal rings - Plastic rings

Suitable for the following chain saws:



MAKE FITS	MODEL	DESCRIPTION	P/N	O.E.M. Ref
STIHL	08-041-045	Metal ring	<b>560115</b>	0000 961 5115
	050-051	Metal ring	<b>560117</b>	1111 195 4100
	08-041-045	Plastic ring	<b>560116</b>	0000 961 5116

STANDARD PACKAGING: 10 PCS. PER NYLON BAG



ORDER IN MULTIPLES OF (10)

## Gasket sets

Suitable for the following chain saws:



MAKE FITS	DESCRIPTION	P/N
HUSQVARNA	61-162-266-268	<b>640145A</b>
PARTNER	K650 ACTIVE	<b>640182</b>
STIHL	034-036	<b>640158A</b>
	08-TS350	<b>640131A</b>
	051	<b>640136A</b>
	024-026	<b>640180A</b>
	TS400	<b>640181A</b>

STANDARD PACKAGING: SKINPACK - 1 SET



## Exhausts

Suitable for the following chain saws:



MAKE FITS	MODEL	P/N	O.E.M. Ref
HUSQVARNA	266	<b>610140</b>	501 65 76-01
STIHL	038-038S	<b>610139</b>	1119 140 0600

STANDARD PACKAGING: 1 PC PER NYLON BAG



## Starter handles

Suitable for the following chain saws:



STIHL	OUR REF.
010-015-020-028-031-032 (Old Mod.)	<b>560119</b>
STANDARD PACKAGING: 10 PCS. PER NYLON BAG	
ORDER IN MULTIPLES OF (10)	



STIHL	OUR REF.
08-038-041-042-048-051-056-070-075 (Old Mod.)	<b>560118</b>
STANDARD PACKAGING: 10 PCS. PER NYLON BAG	
ORDER IN MULTIPLES OF (10)	



STIHL	OUR REF.
Standard (New)	<b>560213</b>
STANDARD PACKAGING: 10 PCS. PER NYLON BAG	
ORDER IN MULTIPLES OF (10)	



HUSQVARNA	OUR REF.
Standard O.E.M. part No. 501 55 14-02	<b>560191</b>
STANDARD PACKAGING: 10 PCS. PER NYLON BAG	
ORDER IN MULTIPLES OF (10)	

## Starter handles

Suitable for the following chain saws:



**STANDARD TYPE-SMALL**

**OUR REF.**

**560121**

STANDARD PACKAGING: 10 PCS. PER NYLON BAG



ORDER IN MULTIPLES OF (10)



**STANDARD TYPE-MEDIUM**

**OUR REF.**

**560120**

STANDARD PACKAGING: 10 PCS. PER NYLON BAG



ORDER IN MULTIPLES OF (10)



**STANDARD TYPE-LARGE COMPLETE WITH PLASTIC CAP**

**OUR REF.**

**560123**

STANDARD PACKAGING: 10 PCS. PER NYLON BAG



ORDER IN MULTIPLES OF (10)

## Spark plugs

Suitable for the following chain saws:



ENGINE	OUR REF.	HEXAGON	SUITABLE FOR		
			BOSCH	CHAMPION	NKG
CHAIN SAW	<b>88501159</b>	19	WS7E	CJ8	BM6A
CHAIN SAW	<b>88501157</b>	19	WS7F	CJ7Y	BPM7A

STANDARD PACKAGING: 10 PCS. PER BOX



ORDER IN MULTIPLES OF (10)

## Chain tighteners

Suitable for the following chain saws:



MAKE FITS	DESCRIPTION	P/N	O.E.M. Ref
HUSQVARNA	51-61-66-162-181-266-268 272-281-288	<b>651172</b>	501 53 71 01
	42-44-50-51-55 238-242-444	<b>651173</b>	501 81 92 01
	154-254-262	<b>651192</b>	501 53 71 01
JONSERED	629-630-670	<b>651172</b>	1118 664 1600
STIHL	08-051-075	<b>651157</b>	1106 644 1500

STANDARD PACKAGING: 10 PCS. PER NYLON BAG



ORDER IN MULTIPLES OF (10)

## Tube handles

Suitable for the following chain saws:



MAKE FITS	DESCRIPTION	P/N	O.E.M. Ref
HUSQVARNA	61-66-266-268-272	<b>654138</b>	501 53 45-03
	50 SPECIAL-51-55-254	<b>654151</b>	501 87 29 07

STANDARD PACKAGING: 1 PC. PER NYLON BAG



## Nuts

Suitable for the following chain saws:



MAKE FITS	DESCRIPTION	P/N		
		BAR	SPROCKET	FLYWHEEL
STIHL	010-015-031-032-041	<b>670101</b>		
	028 (Old)-020	<b>670101</b>		
	042-045	<b>670101</b>		<b>672110</b>
	050-051-075	<b>670113</b>		
	056	<b>670101</b>	<b>671102</b>	<b>672110</b>
	08	<b>670113</b>		<b>672110</b>
	024-028-038-044	<b>670114</b>		

STANDARD PACKAGING: 10 PCS. PER NYLON BAG



ORDER IN MULTIPLES OF (10)



## Ignition coils

Suitable for the following chain saws:



ENGINE	DESCRIPTION	OUR REF.	
		TECOMEC	DUCATI
HUSQVARNA	45-51-55-61-254-257-262 268-272-394-Brusch cutter 250RT-250R-245R240R	<b>502185*</b>	
STIHL	021-023		<b>502169*</b>
	041-045		<b>502901</b>
	038 MAGNUM	<b>502183*</b>	
	051	<b>502184*</b>	
		* ELECTRONIC IGNITION	

STANDARD PACKAGING: 1 PC. PER NYLON BAG



## Spark plug terminals

Suitable for the following chain saws:



SPARK PLUG TERMINAL WITH SPRING	OUR REF.
5 mm wire	<b>506102</b>
7 mm wire	<b>506101</b>
Spring only	<b>506103</b>

STANDARD PACKAGING: 10 PCS. PER NYLON BAG



ORDER IN MULTIPLES OF (10)



SPARK PLUG TERMINAL	OUR REF.
Standard type	<b>506107</b>

STANDARD PACKAGING: 10 PCS. PER NYLON BAG



ORDER IN MULTIPLES OF (10)

## Insulated cable

Suitable for the following chain saws:



RUBBER INSULATED CABLE for high temperatures from -20°++100°C	OUR REF.
ø 5 mm x 1 m	<b>506142</b>
ø 7 mm x 1 m	<b>506143</b>

STANDARD PACKAGING: 10 m PER REEL (NYLON BAG)



The price is per 1 m

RUBBER INSULATED CABLE STANDARD	OUR REF.
ø 5 mm x 1 m	<b>506111</b>
ø 7 mm x 1 m	<b>506112</b>

STANDARD PACKAGING: 10 m PER REEL (NYLON BAG)



The price is per 1 m

## Switches

Suitable for the following chain saws:



SWITCH	OUR REF.
Universal type	<b>506110</b>
HUSQVARNA 61-266-281-288 (O.E.M. Part No. 501 52 66 02)	<b>506163</b>
STANDARD PACKAGING: 10 PCS. PER NYLON BAG	
ORDER IN MULTIPLES OF (10)	

## Wrenches

Suitable for the following chain saws:

MAKE	MODEL	DIMENSIONS (mm)					OUR REF.
		A	B	C	BAR	Plung	
ALPINA	A40-C40-CP45-A70-C70	150	52	33	13	19	<b>2304023</b>
DOLMAR	CA-CC-CT	172	35	35	17	21	<b>2304014</b>
	122-123-144-152-153-133-166-309-310-311	180	34	34	17	19	<b>2304084</b>
	112-113-114-116-117-119-120-120 Super	145	25	25	13	19	<b>2304080</b>
ECHO	CS60-100-452-500-601-605-650-701-750-801-802	150	52	33	13	19	<b>2304023</b>
	280-302-304-315-351-400	150	60	30	10	19	<b>2304077</b>
HOMELITE	XL Series (1° Mod.)-925	150	55	25	16	19	<b>2304020</b>
	Mini	150	45	25	13	16	<b>2304017</b>
	XL Super VI-XL2	145	90	25	11	16	<b>2304027</b>
HUSQVARNA	65-77 (2° Mod.) 140-160-162-480-285-2100	150	52	33	13	19	<b>2304023</b>
	Husky	135	42	23	11	19	<b>2304025</b>
	61-154-181-234-266-44-444	145	25	25	13	19	<b>2304080</b>
JONSERED	625-630-670	127	22	21	13	19	<b>2304080</b>
MC CULLOCH	Standard	150	45	25	13	16	<b>2304017</b>
	Mac 6	145	90	25	11	16	<b>2304027</b>
OLEO MAC	E140-E160-233-240-935X-935DX	150	60	30	10	19	<b>2304077</b>
	254-350-355-945-950-938-941-942-946-951-970-980	150	52	33	13	19	<b>2304023</b>
	271-272-481-482-999	180	34	34	17	19	<b>2304084</b>
PARTNER	330-340	135	42	23	11	19	<b>2304025</b>
	R16-S50-S55-P55-P70-P100	150	52	33	13	19	<b>2304023</b>
PIONEER	P12	135	42	23	11	19	<b>2304025</b>
	P20-P21-P25-P26-P28-P40-P50-1200-1074-C55	150	52	33	13	19	<b>2304023</b>
	P41-P51 Farmsaw-P60	180	34	34	17	19	<b>2304084</b>
POULAN	200-300-400	160	54	24	14	19	<b>2304024</b>
QUADRA	Frontier	135	42	23	11	19	<b>2304025</b>
SOLO	50-70-125	172	35	35	17	21	<b>2304014</b>
	610-620-640-650	150	52	33	13	19	<b>2304023</b>
STIHL	010-015-020-028-031-032-041	170	50	18	13	19	<b>2304010</b>
	010-015-020-028-031-032-041	170	21	34	13	19	<b>2304008</b>
	045-050-051-075	180	34	34	17	19	<b>2304084</b>
	08	172	35	35	17	21	<b>2304014</b>
	Standard-New	175	35	15		19	<b>2304068</b>

STANDARD PACKAGING: 100 PCS. PER BOX

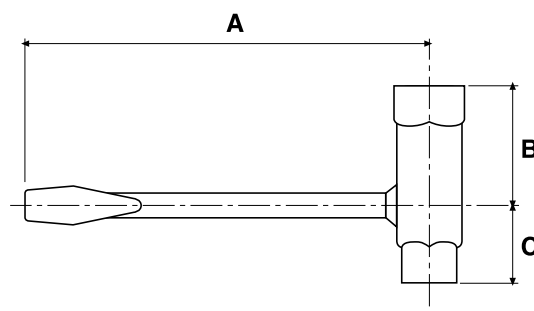

## Wrenches

Suitable for the following chain saws:



**STIHL**

**OUR REF.**

1 - Allen wrench for Stihl screws (TORX 27)  
2 - Wrench for Stihl screws (TORX 27)

**2304074**  
**2304072**

STANDARD PACKAGING: 100 PCS. PER BOX



**ASPERA**

**OUR REF.**

21 x 19 x  $\varnothing$ 11 Square-Aspera and Tecumsen

**2304083**

STANDARD PACKAGING: 100 PCS. PER BOX



**BRIGGS & STRATTON**

**OUR REF.**

24 x 19 x  $\varnothing$ 11 Square-Briggs & Stratton (box 60 pcs)  
21 x 19 x  $\varnothing$ 3/8 Square-Briggs & Stratton Sprint

**2304082**  
**2304076**

STANDARD PACKAGING: 100 PCS. PER BOX





# GENERAL CONDITIONS OF SALE

## Art. 1 - Scope of application of the General Conditions of Sale

1.1 - These general conditions of sale (hereinafter the "Conditions") shall apply to every contract of sale (hereinafter the "Contract") entered into by Tecomec (hereinafter the "Seller") which concerns the products manufactured and/or marketed by the Seller (hereinafter the "Products").

1.2 - Notwithstanding any provision to the contrary and even if any such provision may be contained in any possible general conditions of the buyer of the Products (hereinafter, the "Buyer"), the Conditions shall apply to any offer, any order confirmation and any delivery effected by the Seller, except as expressly provided from time to time in a written document signed by the Seller.

## Art. 2 - Conclusion and effective date of each Contract

2.1 - The Contract of sale of the Products shall be deemed to enter into force (i) at such time as the Seller issues the relevant order confirmation, or in absence of such an order confirmation, (ii) at such time as the Buyer collects the Products.

2.2 - The Buyer's orders will be accepted by the Seller only if said orders contain the specifications which are necessary for the purpose of identifying the Products ordered, it being understood that the Seller shall be entitled, at its sole discretion, to accept or refuse the Buyer's orders.

2.3 - Any possible cancellation of or amendment to any order by the Buyer shall not be effective unless previously authorised or subsequently accepted in writing by the Seller (it being in any event understood that the Seller's commercial agents, intermediaries and/or external consultants shall not have the power to accept the Buyer's orders on behalf of the Seller and/or to formulate or accept any proposal, in such a way as to bind the Seller, relating to discounts, sales allowances and/or variations to the Conditions).

## Art. 3 - Terms of payment and Prices

3.1 - Unless otherwise agreed in writing, the Seller's price list which is in force as of the date of the order confirmation shall apply to any order made by the Buyer. The prices of any Products not appearing on the price list shall be determined by the Seller on a case by case basis.

3.2 - The prices of the Products shall be deemed exclusive of VAT and of any other incidental expense and/or cost (including, but not limited to, bank commissions or expenses, special packaging, insurance, transport), which shall be borne by the Buyer.

Without prejudice to the above, any and all taxes, duties, levies, licences, authorisations, permits and any and all tax and administrative or customs formalities or costs relating to the importation and/or re-sale of the Products shall be borne and carried out exclusively by the Buyer or, alternatively, they may be carried out by the Seller at the Buyer's sole risk, expense and responsibility.

3.3 - Unless otherwise indicated in the order confirmation, payment of the price of the Products will be effected within 30 (thirty) days following the date of issue of the relevant invoice.

Under no circumstances shall the Buyer be entitled to suspend or delay payment of the Products. In the event that the Buyer fails to fulfil its obligations to pay the price (including the obligation to make any possible advance payments), the Seller shall be entitled to postpone the delivery of the Products for a period corresponding to the length of the delay on the part of the Buyer and/or to terminate the Contract, retaining the sums received from the Buyer by way of liquidated damages, without prejudice to the Seller's rights to claim compensation for any further damages suffered.

## Art. 4 - Terms of delivery and packaging

4.1 - All delivery dates as well as delivery terms given in the order confirmation shall be deemed to be indicative only. In the event of possible late delivery, the Buyer shall not be entitled to terminate the Contract or claim compensation for damages of whatever nature (it being in any event understood that by collecting any Products which may have been delivered late, the Buyer waives any and all rights relating to said delay).

4.2 - Unless otherwise agreed in writing between the parties, the delivery of the Products (and the relating transfer of risk) will be effected "EX WORKS" (Incoterms 2000); in the light of the above, the Seller shall not enter into any shipment or transportation agreement and shall not insure the Products to be supplied, unless the Buyer should so expressly instruct the Seller in writing; it being in any event understood that any and all risks and expenses in relation thereto shall be borne exclusively by the Buyer.

4.3 - The Buyer agrees to collect the Products as soon as it receives notice that the Products are ready and at its disposal and, in any event, within 8 (eight) days of the date of said notice. In any event, the transfer of risk and the payment terms shall start running as of the date of the notice that the Products are ready or, in the absence thereof, as of the date of delivery.

4.4 - At the time of delivery of the Products the Buyer shall check the quantity and the specifications of the Products delivered. Any claim by the Buyer in respect of the quantity or the quality of the delivered Products shall be communicated in writing to the Seller within no more than 8 (eight) days following the date of delivery of the Products.

4.5 - The Products shall be delivered by the Seller to the Buyer with appropriate packaging; it being understood that the packaging provided by the Seller is suitable for a period of storage/transit not exceeding 180 (one hundred and eighty) days. Provided that the Buyer advises the Seller sufficiently in advance that the goods may be in storage/transit for a period exceeding 180 (one hundred and eighty) days, then the Seller may supply the Buyer, at the latter's expense, with different packaging.

4.6 - From such time as the Products are delivered, the Buyer undertakes to look after the Products with the requisite care (keeping them in a safe and appropriate place and in such a way that they are not subjected to inappropriate climatic conditions and temperatures), given that the ownership of the Products shall pass to the Buyer only upon payment in full of the sale price of the Products. In the event that the Buyer fails to pay the price, the Seller shall be entitled, without any formalities, including sending a notice of default, to repossess all of the Products with respect to which title has not yet passed to the Buyer, wherever said Products may be; in addition, the Seller shall be entitled to charge interest on arrears at the rate provided by the applicable law (without prejudice to the Seller's right to seek any other judicial remedies available to it in respect of the damages suffered).

## Art. 5 - Characteristics of the Products; Modifications to the Products

5.1 - Any possible information or data relating to the characteristics and/or to the technical specifications of the Products that may be included in brochures, price lists, catalogues, or similar documents are indicative only and not binding, unless otherwise agreed in writing by the parties.

5.2 - The Buyer shall be prohibited from making, directly or indirectly, any changes, modifications or other alterations whatsoever to the Products and should the Buyer breach such obligations, it shall bear any and all liability in respect of the Products, be it foreseeable or unforeseeable, arising out of the Contract, any unlawful act, in equity or otherwise.

5.3 Without prejudice to the above terms, the Seller reserves the right to update, modify or terminate the production of all or any of the Products as determined by the Seller at its sole discretion.

In this regard, the Buyer acknowledges and agrees that changes in technology or in market conditions or in the Seller's sales and marketing policy may prompt the Seller to modify the Product specifications or to cease to manufacture or sell one or more types of the Products and that the Seller shall not be in any way liable to the Buyer for any possible damages, be they direct or indirect, which may be suffered by the Buyer as a result of such decision by the Seller.

## Art. 6 - Liability

6.1 - Without prejudice to the limitations of the warranty as per Art. 7 below, the Seller's total liability may not in any event exceed an amount equal to 7% (seven percent) of the price agreed for the Products in respect of which the claim occurs.

6.2 - The Buyer undertakes to read and make itself acquainted with the specifications of the Products and the instructions and warnings supplied in relation to the use that may be made of said Products and the use for which the Products may be reasonably intended. In addition, the Buyer shall ensure that the Products will only be marketed as of such time as they comply with all laws, regulations and other rules (relating to packaging, instructions, information, and in general, to the safety of persons and goods) provided by the country in which the Products will be marketed. The Buyer shall be solely responsible for ensuring that the use and marketing of the Products are correct and in compliance with the above-mentioned regulations and laws, in addition to the requirements of the Buyer's customers and good technique and the Buyer shall indemnify and hold the Seller harmless with regard to the terms of this Art. 6.2.

## Art. 7 - Warranty

7.1 - The Seller warrants the quality of the Products for a period of 12 (twelve) months following the date of delivery, subject to the customary tolerances and excluding those defects which may arise due to transportation, improper use or inappropriate storage or maintenance of the Products. Any other damages, including any possible damages resulting from the lack of or a reduction in production, in addition to any indirect, consequential, special or incidental or damages of a punitive nature, are expressly excluded from the warranty.

7.2 - The warranty shall be subject to the Buyer duly informing the Seller in writing, within 8 (eight) days following the discovery thereof, of the particular defect or lack of quality, failing which the Buyer shall lose its rights under the warranty in respect thereof, and shall also be subject to the Buyer making an express written request to the Seller to provide assistance under the warranty.

7.3 - The warranty consists in either the repair or replacement, at the Seller's sole discretion and at its expense, of the Products which may prove to be broken or defective due to manufacturing defects. The Seller shall replace or repair the defective parts in the shortest time possible (which shall be calculated on a case by case basis) and the Seller shall have the right to request the Buyer to return the defective parts and/or the Products which have been replaced.

7.4 - Any other warranty relating to the Products, including without limitation, any warranties provided by law, shall be deemed excluded and superseded by these Conditions.

## Art. 8 - Returned Products

8.1 - The Products may be returned by the Buyer to the Seller only if the Seller has given its prior written authorisation in relation thereto. It is in any event understood that if the Buyer does not collect the Products within a period of 6 (six) months after they have been returned to the Seller (regardless of whether the return is unauthorised or in relation to Products which are no longer under warranty), the Seller shall be entitled to scrap said Products and to charge the Buyer the relevant costs, without prejudice to the Seller's right to be reimbursed by the Buyer for the costs relating to the storage of the returned Products.

## Art. 9 - Force Majeure

9.1 - The Seller shall not be liable vis-à-vis the Buyer for any failure to perform, including late delivery or failure to deliver, which is caused by occurrences beyond the Seller's reasonable control or in any case caused by an event of force majeure, including, but not limited to, late delivery or non-delivery of manufacturing materials by suppliers, strikes and other trade union actions, suspension of electrical energy or difficulties in transportation.

9.2 - Upon the occurrence of any event of force majeure which is such as to prevent either party hereto from fulfilling its obligations hereunder, then the time for the party so affected to fulfil its obligations shall be automatically extended for a period corresponding to the duration of the event of force majeure, save for the Buyer's obligation to pay the amounts due by way of the price, in respect of which the contractually agreed due dates shall remain in full force and effect.

## Art. 10 - Applicable Law and jurisdiction

10.1 - These Conditions and all contracts of sale to which the Seller and the Buyer are a party shall be exclusively governed by Italian law (including the provisions of the Vienna Convention 1980, relating to contracts for the international sale of goods, which are not derogated by these Conditions).

10.2 - Any and all disputes arising out of or relating to the signing, interpretation, execution and termination for any reason whatever of these Conditions and of the contracts of sale to which the Seller and the Buyer are a party, shall be settled exclusively by the courts of competent jurisdiction for the place in which the Seller's registered office is located. Notwithstanding the foregoing, the Seller may bring an action against the Buyer before any court having jurisdiction over the Buyer.

# Precision Tooling

 **Precision Tooling®**

Reggio Emilia - Italy

Tel. +39.0522.959001

Fax +39.0522.953033

+39.0522.959060

[www.precisiontooling.it](http://www.precisiontooling.it)