

# Filtri di aspirazione e mandata

## Suction and line filters

### Filtres d'aspiration et filtres en ligne

#### CARATTERISTICHE TECNICHE

I **filtri di aspirazione** GEOLINE vengono realizzati in polipropilene, con guarnizioni in EPDM (Viton® a richiesta), particolari metallici interni in acciaio inox AISI 304, particolari metallici esterni di fissaggio in ottone, cartucce filtranti in polipropilene con reti in acciaio inox AISI 304 o in polipropilene.

I **filtri di mandata** GEOLINE vengono realizzati in polipropilene o nylon rinforzato con fibra di vetro, ghiera in polipropilene rinforzato con fibra di vetro, guarnizioni di tenuta in EPDM (Viton® a richiesta), particolari metallici interni in acciaio inox AISI 304, cartucce filtranti in polipropilene con reti in acciaio inox AISI 304.

Filtri di aspirazione  
Filtri di mandata  
Filtri in ottone

#### TECHNICAL FEATURES

GEOLINE **suction filters** are in polypropylene, with EPDM gaskets (Viton® on demand), internal mechanical details in AISI 304 stainless steel, external fastening brass details, polypropylene filtering cartridge with AISI 304 stainless steel or polypropylene mesh.

GEOLINE **line filters** are in polypropylene or fiberglass reinforced nylon, with polypropylene back nuts, EPDM seals (Viton® on demand), internal mechanical components in AISI 304 stainless steel, polypropylene filtering cartridge with AISI 304 stainless steel mesh.

Suction filters  
Line filters  
Brass line filters

#### CARACTERISTIQUES TECHNIQUES

Les **filtres d'aspiration** GEOLINE sont en polypropylène, avec joints en EPDM (Viton® sur demande), parties intérieures mécaniques en acier inoxydable AISI 304, dispositifs de fixation extérieurs en laiton, cartouches filtrantes en polypropylène avec mailles en acier inoxydable AISI 304 ou en polypropylène.

Les **filtres en ligne** GEOLINE sont en polypropylène ou en nylon renforcé par des fibres de verre, avec des embouts en polypropylène, des joints d'étanchéité en EPDM (Viton® sur demande), des parties intérieures en acier inoxydable AISI 304 et des cartouches filtrantes en polypropylène avec mailles en acier inoxydable AISI 304.

Filtres d'aspiration  
Filtres en ligne  
Filtres en ligne en laiton

#### Legenda



Per atomizzatori  
For orchard sprayers  
Pour atomiseurs



Per macchine a basso volume  
For low-volume spraying machines  
Pour machines basse volum



Per macchine da diserbo  
For crop sprayers  
Pour pulverisateurs



Portata della pompa  
Pump flow rate  
Débit de la pompe



Portata  
Flow rate  
Débit



Pressione d'esercizio  
Operating pressure  
Pression de service

- Filtri di aspirazione e mandata
- Suction and line filters
- Filtres d'aspiration et filtres en ligne

Filtri di aspirazione con valvola per portate fino a 260 l/min

Suction filters with valve for flow rates up to 260 l/min (58 US GPM)

Filtres d'aspiration avec vanne pour débits jusqu'à 260 l/min.

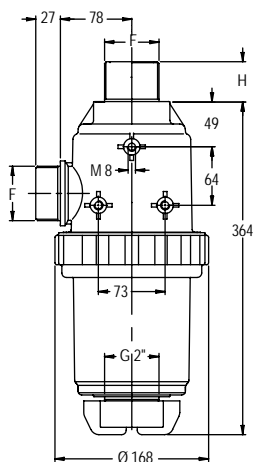

Part No.	F	Screen	H mm	Effective area cm <sup>2</sup>	Sq.in.	Pack
<b>8096000</b>		INOX 32 Mesh		342	53	
<b>8096001</b>	2"	INOX 50 Mesh	27	314	49	8
<b>8096002</b>		INOX 80 Mesh		286	44	
<b>8096003</b>		INOX 32 Mesh		342	53	
<b>8096004</b>	2"	INOX 50 Mesh	44	314	49	8
<b>8096005</b>		INOX 80 Mesh		286	44	

Spare parts

Part No.	Screen	Gasket
<b>C00100055</b>	INOX 16 Mesh	G00001042
<b>C00100046</b>	INOX 32 Mesh	
<b>C00100047</b>	INOX 50 Mesh	
<b>C00100048</b>	INOX 80 Mesh	

Filtri di aspirazione per portate fino a 260 l/min.

Suction filters for flow rates up to 260 l/min (58 US GPM).

Filtres d'aspiration pour débits jusqu'à 260 l/min.

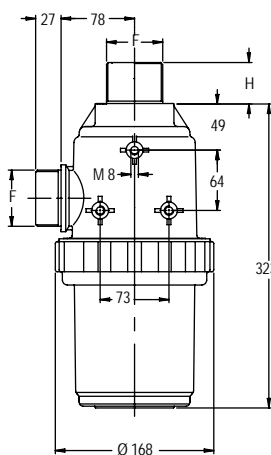

Part No.	F	Screen	H mm	Effective area cm <sup>2</sup>	Sq.in.	Pack
<b>8095000</b>		INOX 32 Mesh		342	53	
<b>8095001</b>	2"	INOX 50 Mesh	27	314	49	8
<b>8095002</b>		INOX 80 Mesh		286	44	
<b>8095003</b>		INOX 32 Mesh		342	53	
<b>8095004</b>	2"	INOX 50 Mesh	44	314	49	8
<b>8095005</b>		INOX 80 Mesh		286	44	

Spare parts

Part No.	Screen	Gasket
<b>C00100055</b>	INOX 16 Mesh	G00001042
<b>C00100046</b>	INOX 32 Mesh	
<b>C00100047</b>	INOX 50 Mesh	
<b>C00100048</b>	INOX 80 Mesh	

Filtri di aspirazione con valvola per portate fino a 220 l/min.

Suction filters with valve for flow rates up to 220 l/min (58 US GPM).

Filtres d'aspiration avec vanne pour débits jusqu'à 220 l/min.

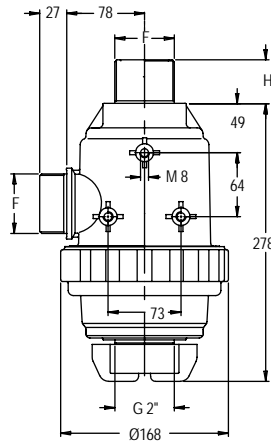

Part No.	F	Screen	H mm	Effective area cm <sup>2</sup>	Sq.in.	Pack
8092000		INOX 32 Mesh		242	37,5	
8092001	2"	INOX 50 Mesh	27	222	34,5	8
8092002		INOX 80 Mesh		203	31,4	
8092003		INOX 32 Mesh		242	37,5	
8092004	2"	INOX 50 Mesh	44	222	34,5	8
8092005		INOX 80 Mesh		203	31,4	

Spare parts

Part No.	Screen	Gasket
C00100056	INOX 16 Mesh	G00001042
C00100008	INOX 32 Mesh	
C00100009	INOX 50 Mesh	
C00100010	INOX 80 Mesh	

Filtri di aspirazione per portate fino a 220 l/min.

Suction filters for flow rates up to 220 l/min (58 US GPM).

Filtres d'aspiration pour débits jusqu'à 220 l/min.

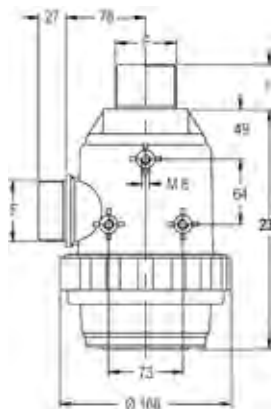

Part No.	F	Screen	H mm	Effective area cm <sup>2</sup>	Sq.in.	Pack
8091000		INOX 32 Mesh		242	37,5	
8091001	2"	INOX 50 Mesh	27	222	34,5	8
8091002		INOX 80 Mesh		203	31,4	
8091003		INOX 32 Mesh		242	37,5	
8091004	2"	INOX 50 Mesh	44	222	34,5	8
8091005		INOX 80 Mesh		203	31,4	

Spare parts

Part No.	Screen	Gasket
C00100056	INOX 16 Mesh	G00001042
C00100008	INOX 32 Mesh	
C00100009	INOX 50 Mesh	
C00100010	INOX 80 Mesh	

- Filtri di aspirazione e mandata
- Suction and line filters
- Filtres d'aspiration et filtres en ligne

Filtri di aspirazione con valvola per portate fino a 180 l/min.

Suction filters with valve for flow rates up to 180 l/min (47 US GPM).

Filtres d'aspiration avec vanne pour débits jusqu'à 180 l/min.

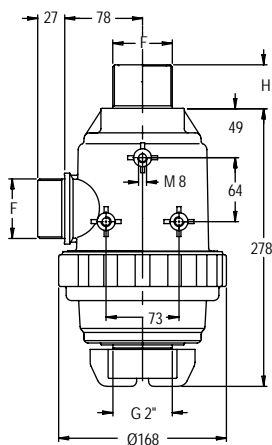

Part No.	F	Screen	H mm	Effective area cm <sup>2</sup>	Sq.in.	Pack
<b>8088000</b>		INOX 32 Mesh		242	37,5	
<b>8088001</b>	1"1/2	INOX 50 Mesh	24	222	34,5	8
<b>8088002</b>		INOX 80 Mesh		203	31,4	
<b>8088003</b>		INOX 32 Mesh		242	37,5	
<b>8088004</b>	1"1/2	INOX 50 Mesh	44	222	34,5	8
<b>8088005</b>		INOX 80 Mesh		203	31,4	

Spare parts

Part No.	Screen	Gasket
<b>C00100056</b>	INOX 16 Mesh	G00001042
<b>C00100008</b>	INOX 32 Mesh	
<b>C00100009</b>	INOX 50 Mesh	
<b>C00100010</b>	INOX 80 Mesh	

Filtri di aspirazione per portate fino a 180 l/min.

Suction filters for flow rates up to 180 l/min (47 US GPM).

Filtres d'aspiration pour débits jusqu'à 180 l/min.

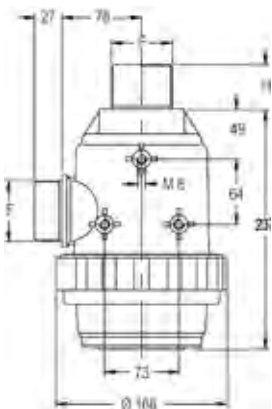

Part No.	F	Screen	H mm	Effective area cm <sup>2</sup>	Sq.in.	Pack
<b>8087000</b>		INOX 32 Mesh		242	37,5	
<b>8087001</b>	1"1/2	INOX 50 Mesh	24	222	34,5	8
<b>8087002</b>		INOX 80 Mesh		203	31,4	
<b>8087003</b>		INOX 32 Mesh		242	37,5	
<b>8087004</b>	1"1/2	INOX 50 Mesh	44	222	34,5	8
<b>8087005</b>		INOX 80 Mesh		203	31,4	

Spare parts

Part No.	Screen	Gasket
<b>C00100056</b>	INOX 16 Mesh	G00001042
<b>C00100008</b>	INOX 32 Mesh	
<b>C00100009</b>	INOX 50 Mesh	
<b>C00100010</b>	INOX 80 Mesh	

Filtri di aspirazione con valvola per portate fino a 150 l/min.

Suction filters with valve for flow rates up to 150 l/min (40 US GPM).

Filtres d'aspiration avec vanne pour débits jusqu'à 150 l/min.

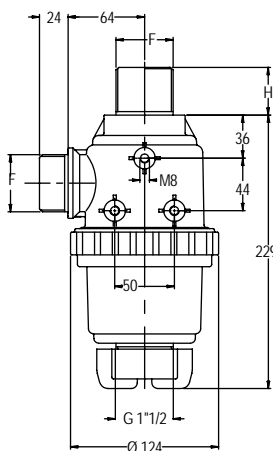

Part No.	F	Screen	H mm	Effective area cm <sup>2</sup>	Sq.in.	Pack
8082000		INOX 32 Mesh		138	21,4	
8082001	1"1/2	INOX 50 Mesh	24	126	19,5	10
8082002		INOX 80 Mesh		115	17,8	
8082003		INOX 32 Mesh		138	21,4	
8082004	1"1/2	INOX 50 Mesh	40	126	19,5	10
8082005		INOX 80 Mesh		115	17,8	

Spare parts

Part No.	Screen	Gasket
C00100011	INOX 32 Mesh	G00001040
C00100012	INOX 50 Mesh	
C00100013	INOX 80 Mesh	

Filtri di aspirazione per portate fino a 150 l/min.

Suction filters for flow rates up to 150 l/min (40 US GPM).

Filtres d'aspiration pour débits jusqu'à 150 l/min.

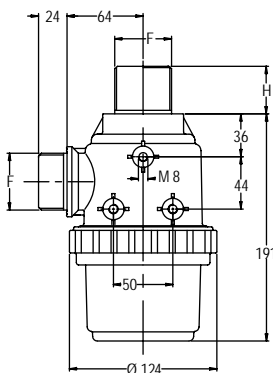

Part No.	F	Screen	H mm	Effective area cm <sup>2</sup>	Sq.in.	Pack
8081000		INOX 32 Mesh		138	21,4	
8081001	1"1/2	INOX 50 Mesh	27	126	19,5	10
8081002		INOX 80 Mesh		115	17,8	
8081003		INOX 32 Mesh		138	21,4	
8081004	1"1/2	INOX 50 Mesh	44	126	19,5	10
8081005		INOX 80 Mesh		115	17,8	

Spare parts

Part No.	Screen	Gasket
C00100011	INOX 32 Mesh	G00001040
C00100012	INOX 50 Mesh	
C00100013	INOX 80 Mesh	

- Filtri di aspirazione e mandata
- Suction and line filters
- Filtres d'aspiration et filtres en ligne

Filtri di aspirazione con valvola per portate fino a 150 l/min.

Suction filters with valve for flow rates up to 150 l/min (40 US GPM).

Filtres d'aspiration avec vanne pour débits jusqu'à 150 l/min.

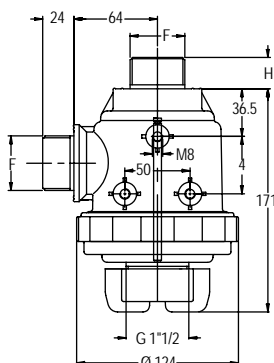

Part No.	F	Screen	H mm	Effective area cm <sup>2</sup>	Sq.in.	Pack
<b>8080000</b>		INOX 32 Mesh		86	13,3	
<b>8080001</b>	1"1/2	INOX 50 Mesh	24	79	12,3	10
<b>8080002</b>		INOX 80 Mesh		72	11,2	
<b>8080003</b>		INOX 32 Mesh		86	13,3	
<b>8080004</b>	1"1/2	INOX 50 Mesh	40	79	12,3	10
<b>8080005</b>		INOX 80 Mesh		72	11,2	

Spare parts

Part No.	Screen	Gasket
<b>C00100017</b>	INOX 32 Mesh	
<b>C00100018</b>	INOX 50 Mesh	G00001040
<b>C00100019</b>	INOX 80 Mesh	

Filtri di aspirazione per portate fino a 150 l/min.

Suction filters for flow rates up to 150 l/min (40 US GPM).

Filtres d'aspiration pour débits jusqu'à 150 l/min.

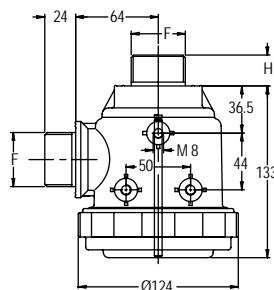

Part No.	F	Screen	H mm	Effective area cm <sup>2</sup>	Sq.in.	Pack
<b>8079000</b>		INOX 32 Mesh		86	13,3	
<b>8079001</b>	1"1/2	INOX 50 Mesh	24	79	12,3	10
<b>8079002</b>		INOX 80 Mesh		72	11,2	
<b>8079003</b>		INOX 32 Mesh		86	13,3	
<b>8079004</b>	1"1/2	INOX 50 Mesh	40	79	12,3	10
<b>8079005</b>		INOX 80 Mesh		72	11,2	

Spare parts

Part No.	Screen	Gasket
<b>C00100017</b>	INOX 32 Mesh	
<b>C00100018</b>	INOX 50 Mesh	G00001040
<b>C00100019</b>	INOX 80 Mesh	



Filtri di aspirazione con valvola per portate fino a 120 l/min.

Suction filters with valve for flow rates up to 120 l/min (32 US GPM).

Filtres d'aspiration avec vanne pour débits jusqu'à 120 l/min.

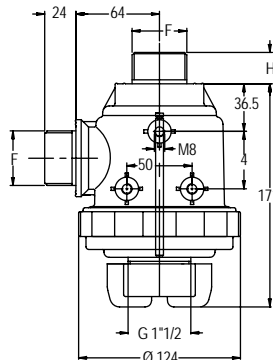

Part No.	F	Screen	H mm	Effective area cm <sup>2</sup>	Sq.in.	Pack
8078000		INOX 32 Mesh		86	13,3	
8078001	1"1/4	INOX 50 Mesh	24	79	12,3	10
8078002		INOX 80 Mesh		72	76	
8078006		INOX 100 Mesh		76	12	
8078003		INOX 32 Mesh		86	13,3	
8078004	1"1/4	INOX 50 Mesh	40	79	12,3	10
8078005		INOX 80 Mesh		72	76	
8078007		INOX 100 Mesh		76	12	

Spare parts

Part No.	Screen	Gasket
C00100017	INOX 32 Mesh	G00001040
C00100018	INOX 50 Mesh	
C00100019	INOX 80 Mesh	
C00100050	INOX 100 Mesh	

Filtri di aspirazione per portate fino a 120 l/min.

Suction filters for flow rates up to 120 l/min (32 US GPM).

Filtres d'aspiration pour débits jusqu'à 120 l/min.

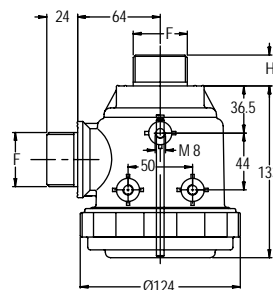

Part No.	F	Screen	H mm	Effective area cm <sup>2</sup>	Sq.in.	Pack
8077000		INOX 32 Mesh		86	13,3	
8077001	1"1/4	INOX 50 Mesh	24	79	12,3	10
8077002		INOX 80 Mesh		72	76	
8077006		INOX 100 Mesh		76	12	
8077003		INOX 32 Mesh		86	13,3	
8077004	1"1/4	INOX 50 Mesh	40	79	12,3	10
8077005		INOX 80 Mesh		72	76	
8077007		INOX 100 Mesh		76	12	

Spare parts

Part No.	Screen	Gasket
C00100017	INOX 32 Mesh	G00001040
C00100018	INOX 50 Mesh	
C00100019	INOX 80 Mesh	
C00100050	INOX 100 Mesh	

- Filtri di aspirazione e mandata
- Suction and line filters
- Filtres d'aspiration et filtres en ligne

Filtri di aspirazione per portate fino a 100 l/min.

Suction filters for flow rates up to 100 l/min (26 US GPM).

Filtres d'aspiration pour débits jusqu'à 100 l/min.

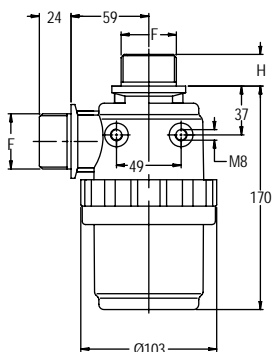

Part No.	F	Screen	H mm	Effective area cm <sup>2</sup>	Sq.in.	Pack
<b>8074000</b>		INOX 32 Mesh		105	16,3	
<b>8074001</b>		INOX 50 Mesh		97	15	
<b>8074002</b>		PP 18 Mesh	24	90	14	10
<b>8074003</b>		PP 32 Mesh		69	10,7	
<b>8074008</b>	1"1/4	INOX 100 Mesh		94	14,5	
<b>8074004</b>		INOX 32 Mesh		105	16,3	
<b>8074005</b>		INOX 50 Mesh		97	15	
<b>8074006</b>		PP 18 Mesh	40	90	14	10
<b>8074007</b>		PP 32 Mesh		69	10,7	
<b>8074009</b>		INOX 100 Mesh		94	14,5	

Spare parts

	Part No.	Screen	Gasket
	<b>C00100020</b>	INOX 32 Mesh	
	<b>C00100021</b>	INOX 50 Mesh	
	<b>C00100036</b>	INOX 100 Mesh	G00001034
	<b>C00100022</b>	PP 18 Mesh	
	<b>C00100023</b>	PP 32 Mesh	

Filtri di aspirazione per portate fino a 60 l/min.

Suction filters for flow rates up to 60 l/min (16 US GPM).

Filtres d'aspiration pour débits jusqu'à 60 l/min.

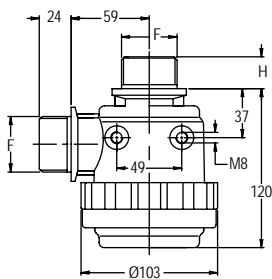

Part No.	F	Screen	H mm	Effective area cm <sup>2</sup>	Sq.in.	Pack
<b>8072000</b>		INOX 32 Mesh		66	10,3	
<b>8072001</b>		INOX 50 Mesh		61	9,4	
<b>8072002</b>		PP 18 Mesh	24	56	8,7	10
<b>8072003</b>		PP 32 Mesh		43	6,7	
<b>8072004</b>	1"1/4	INOX 32 Mesh		66	10,3	
<b>8072005</b>		INOX 50 Mesh		61	9,4	
<b>8072006</b>		PP 18 Mesh	40	56	8,7	10
<b>8072007</b>		PP 32 Mesh		43	6,7	

Spare parts

	Part No.	Screen	Gasket
	<b>C00100024</b>	INOX 32 Mesh	
	<b>C00100025</b>	INOX 50 Mesh	
	<b>C00100026</b>	PP 18 Mesh	G00001034
	<b>C00100027</b>	PP 32 Mesh	



Filtri di mandata per pressioni di esercizio fino a 15 bar.

Line filters for pressures up to 15 bar (220 PSI).

Filtres en ligne pour pressions jusqu'à 15 bar .

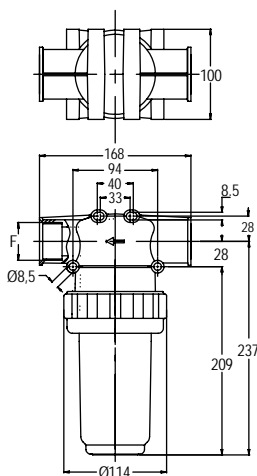

Part No.	F	 I/1'	Screen	Effective area		Pack
				cm <sup>2</sup>	Sq.in.	
<b>8121000</b>	1"1/4	200	INOX 32 Mesh	116	18	5
<b>8121001</b>			INOX 50 Mesh	106	16,4	
<b>8121002</b>			INOX 80 Mesh	97	15	
<b>8121003</b>			INOX 100 Mesh	103	16	
<b>8121004</b>	1"1/2	280	INOX 32 Mesh	116	18	5
<b>8121005</b>			INOX 50 Mesh	106	16,4	
<b>8121006</b>			INOX 80 Mesh	97	15	
<b>8121007</b>			INOX 100 Mesh	103	16	

Spare parts

	Part No.	Screen	Gasket
	<b>C00100032</b>	INOX 32 Mesh	G00001046
	<b>C00100033</b>	INOX 50 Mesh	
	<b>C00100034</b>	INOX 80 Mesh	
	<b>C00100035</b>	INOX 100 Mesh	

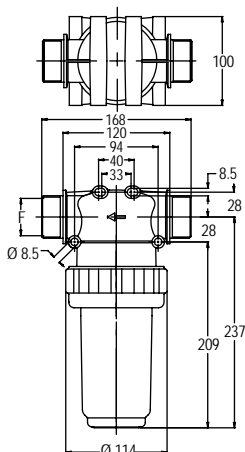

Part No.	F	 I/1'	Screen	Effective area		Pack
				cm <sup>2</sup>	Sq.in.	
<b>8127000</b>	1"1/4	200	INOX 32 Mesh	116	18	5
<b>8127001</b>			INOX 50 Mesh	106	16,4	
<b>8127002</b>			INOX 80 Mesh	97	15	
<b>8127003</b>			INOX 100 Mesh	103	16	
<b>8127004</b>	1"1/2	280	INOX 32 Mesh	116	18	5
<b>8127005</b>			INOX 50 Mesh	106	16,4	
<b>8127006</b>			INOX 80 Mesh	97	15	
<b>8127007</b>			INOX 100 Mesh	103	16	

Spare parts

	Part No.	Screen	Gasket
	<b>C00100032</b>	INOX 32 Mesh	G00001046
	<b>C00100033</b>	INOX 50 Mesh	
	<b>C00100034</b>	INOX 80 Mesh	
	<b>C00100035</b>	INOX 100 Mesh	

- Filtri di aspirazione e mandata
- Suction and line filters
- Filtres d'aspiration et filtres en ligne

Filtri di mandata per pressioni di esercizio fino a 20 bar.

Line filters with for pressures up to 20 bar (290 PSI).

Filtres en ligne pour pressions jusqu'à 20 bar.



**G 1/2" - 3/4"**

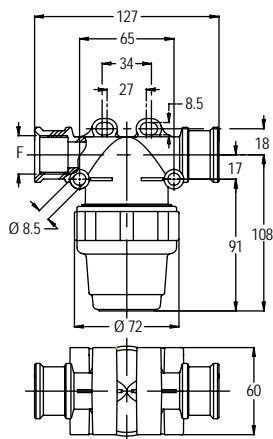

Spare parts G 1/2" - 3/4"

	Part No.	Screen	Gasket
	<b>C00100000</b>	INOX 32 Mesh	G00001024
	<b>C00100001</b>	INOX 50 Mesh	
	<b>C00100002</b>	INOX 80 Mesh	
	<b>C00100003</b>	INOX 100 Mesh	

Part No.	F		Screen	Effective area cm <sup>2</sup>	Sq.in.	Pack
<b>8105000</b>	1/2"	80	INOX 32 Mesh	26	4	10
<b>8105001</b>			INOX 50 Mesh	24	3,7	
<b>8105002</b>			INOX 80 Mesh	22	3,4	
<b>8105003</b>			INOX 100 Mesh	23	3,6	
<b>8105004</b>	3/4"	100	INOX 32 Mesh	26	4	10
<b>8105005</b>			INOX 50 Mesh	24	3,7	
<b>8105006</b>			INOX 80 Mesh	22	3,4	
<b>8105007</b>			INOX 100 Mesh	23	3,6	
<b>8105008</b>	1"	150	INOX 32 Mesh	38	5,9	10
<b>8105009</b>			INOX 50 Mesh	35	5,4	
<b>8105010</b>			INOX 80 Mesh	32	5	
<b>8105011</b>			INOX 100 Mesh	34	5,3	



**G 1"**

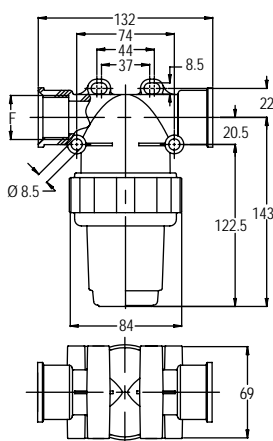

Spare parts G 1"

	Part No.	Screen	Gasket
	<b>C00100004</b>	INOX 32 Mesh	G00001024
	<b>C00100005</b>	INOX 50 Mesh	
	<b>C00100006</b>	INOX 80 Mesh	
	<b>C00100007</b>	INOX 100 Mesh	

Filtri di mandata per pressioni di esercizio fino a 20 bar.

Line filters for pressures up to 20 bar (290 PSI).

Filtres en ligne pour pressions jusqu'à 20 bar.



**G 1/2" - 3/4"**

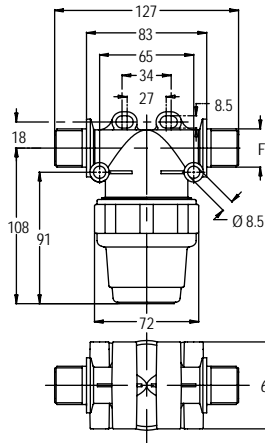

Spare parts G 1/2" - 3/4"

Part No.	Screen	Gasket
<b>C00100000</b>	INOX 32 Mesh	G00001024
<b>C00100001</b>	INOX 50 Mesh	
<b>C00100002</b>	INOX 80 Mesh	
<b>C00100003</b>	INOX 100 Mesh	

Part No.	F	 I/1'	Screen	Effective area		Pack
				cm <sup>2</sup>	Sq.in.	
<b>8110000</b>	1/2"	80	INOX 32 Mesh	26	4	10
<b>8110001</b>			INOX 50 Mesh	24	3,7	
<b>8110002</b>			INOX 80 Mesh	22	3,4	
<b>8110003</b>			INOX 100 Mesh	23	3,6	
<b>8110004</b>	3/4"	100	INOX 32 Mesh	26	4	10
<b>8110005</b>			INOX 50 Mesh	24	3,7	
<b>8110006</b>			INOX 80 Mesh	22	3,4	
<b>8110007</b>			INOX 100 Mesh	23	3,6	
<b>8110008</b>	1"	150	INOX 32 Mesh	38	5,9	10
<b>8110009</b>			INOX 50 Mesh	35	5,4	
<b>8110010</b>			INOX 80 Mesh	32	5	
<b>8110011</b>			INOX 100 Mesh	34	5,3	



**G 1"**

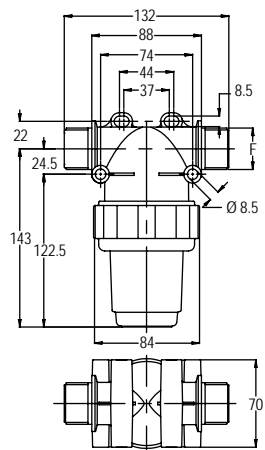

Spare parts G 1"

Part No.	Screen	Gasket
<b>C00100004</b>	INOX 32 Mesh	G00001024
<b>C00100005</b>	INOX 50 Mesh	
<b>C00100006</b>	INOX 80 Mesh	
<b>C00100007</b>	INOX 100 Mesh	

- Filtri di aspirazione e mandata
- Suction and line filters
- Filtres d'aspiration et filtres en ligne

Filtri di mandata autopulenti per pressioni di esercizio fino a 15 bar con filetti femmina.

Self-cleaning line filters for pressures up to 15 bar (250 PSI) - female threads.

Filtres en ligne autonettoyants pour pressions jusqu'à 15 bar - filetage femelle.

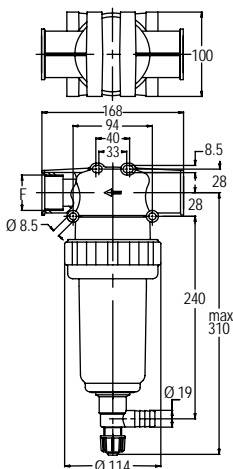

Part No.	F	I/1"	Screen	Effective area		Pack
				cm <sup>2</sup>	Sq.in.	
<b>8122000</b>	1"1/4	200	INOX 32 Mesh	116	18	5
<b>8122001</b>			INOX 50 Mesh	106	16,4	
<b>8122002</b>			INOX 80 Mesh	97	15	
<b>8122003</b>			INOX 100 Mesh	103	16	
<b>8122004</b>	1"1/2	280	INOX 32 Mesh	116	18	5
<b>8122005</b>			INOX 50 Mesh	106	16,4	
<b>8122006</b>			INOX 80 Mesh	97	15	
<b>8122007</b>			INOX 100 Mesh	103	16	

Spare parts

	Part No.	Screen	Gasket
	<b>C00100032</b>	INOX 32 Mesh	G00001046
	<b>C00100033</b>	INOX 50 Mesh	
	<b>C00100034</b>	INOX 80 Mesh	
	<b>C00100035</b>	INOX 100 Mesh	

Filtri di mandata autopulenti per pressioni di esercizio fino a 15 bar con filetti maschio.

Self-cleaning line filters for pressures up to 15 bar (220 PSI) - male threads.

Filtres en ligne autonettoyants pour pressions jusqu'à 15 bar - filetage mâle.

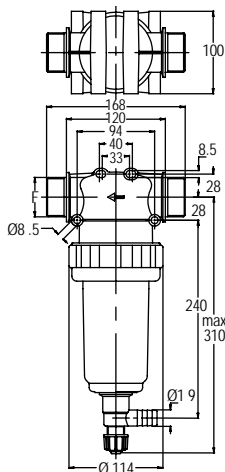

Part No.	F	I/1"	Screen	Effective area		Pack
				cm <sup>2</sup>	Sq.in.	
<b>8128000</b>	1"1/4	200	INOX 32 Mesh	116	18	5
<b>8128001</b>			INOX 50 Mesh	106	16,4	
<b>8128002</b>			INOX 80 Mesh	97	15	
<b>8128003</b>			INOX 100 Mesh	103	16	
<b>8128004</b>	1"1/2	280	INOX 32 Mesh	116	18	5
<b>8128005</b>			INOX 50 Mesh	106	16,4	
<b>8128006</b>			INOX 80 Mesh	97	15	
<b>8128007</b>			INOX 100 Mesh	103	16	

Spare parts

	Part No.	Screen	Gasket
	<b>C00100032</b>	INOX 32 Mesh	G00001046
	<b>C00100033</b>	INOX 50 Mesh	
	<b>C00100034</b>	INOX 80 Mesh	
	<b>C00100035</b>	INOX 100 Mesh	

Filtri di mandata autopulenti per pressioni di esercizio fino a 20 bar con filetti femmina.

Self-cleaning line filters for pressures up to 20 bar (290 PSI) - female threads.

Filtres en ligne autonettoyants pour pressions jusqu'à 20 bar - filetage femelle.

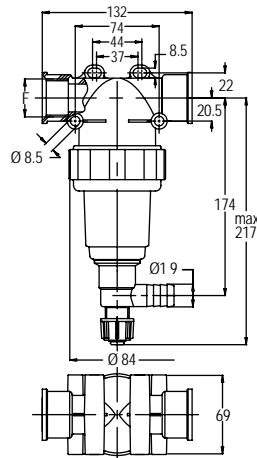

Part No.	F	1/1'	Screen	Effective area		Pack
				cm <sup>2</sup>	Sq.in.	
8106000			INOX 32 Mesh	38	5,9	
8106001	1"	150	INOX 50 Mesh	35	5,4	10
8106002			INOX 80 Mesh	32	5	
8106003			INOX 100 Mesh	34	5,3	

Spare parts

	Part No.	Screen	Gasket
	C00100004	INOX 32 Mesh	G00001024
	C00100005	INOX 50 Mesh	
	C00100006	INOX 80 Mesh	
	C00100007	INOX 100 Mesh	

Filtri di mandata autopulenti per pressioni di esercizio fino a 20 bar con filetti maschio.

Self-cleaning line filters for pressures up to 20 bar (290 PSI) - male threads.

Filtres en ligne autonettoyants pour pressions jusqu'à 20 bar - filetage mâle.

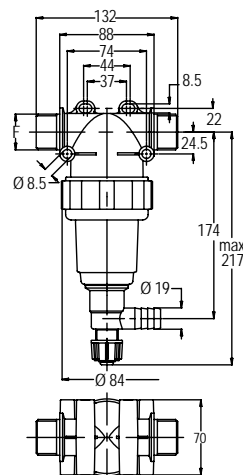

Part No.	F	1/1'	Screen	Effective area		Pack
				cm <sup>2</sup>	Sq.in.	
8111000			INOX 32 Mesh	38	5,9	
8111001	1"	150	INOX 50 Mesh	35	5,4	10
8111002			INOX 80 Mesh	32	5	
8111003			INOX 100 Mesh	34	5,3	

Spare parts

	Part No.	Screen	Gasket
	C00100004	INOX 32 Mesh	G00001024
	C00100005	INOX 50 Mesh	
	C00100006	INOX 80 Mesh	
	C00100007	INOX 100 Mesh	

- Filtri di aspirazione e mandata
- Suction and line filters
- Filtres d'aspiration et filtres en ligne

Filtri di mandata per pressioni di esercizio fino a 10 bar (220 PSI). Con filetti femmina.

Line filters for pressures up to 10 bar (145 PSI). Female threads.

Filtres en ligne pour pressions jusqu'à 10 bar (220 PSI). Filetage femelle.

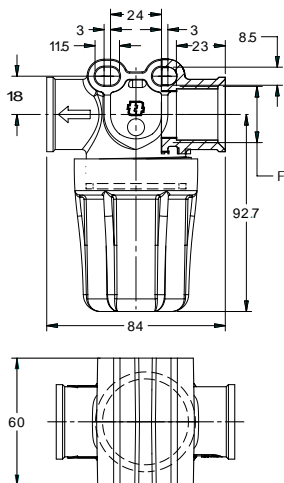

Part No.	F		Screen	Effective area		Pack
				cm <sup>2</sup>	Sq.in.	
<b>8105024</b>	G 3/4"	55	INOX 32 Mesh	25,6	4.0	10
<b>8105025</b>			INOX 50 Mesh	23,5	3.6	
<b>8105026</b>			INOX 80 Mesh	25,6	4.0	
<b>8105027</b>			INOX 100 Mesh	21,5	3.3	
<b>8105032</b>	G 1/2"	55	INOX 32 Mesh	25,6	4.0	10
<b>8105033</b>			INOX 50 Mesh	23,5	3.6	
<b>8105034</b>			INOX 80 Mesh	25,6	4.0	
<b>8105035</b>			INOX 100 Mesh	21,5	3.3	

Spare parts

	Part No.	Screen	Gasket
	<b>C00100057</b>	INOX 32 Mesh	G00002052
	<b>C00100058</b>	INOX 50 Mesh	
	<b>C00100059</b>	INOX 80 Mesh	
	<b>C00100060</b>	INOX 100 Mesh	

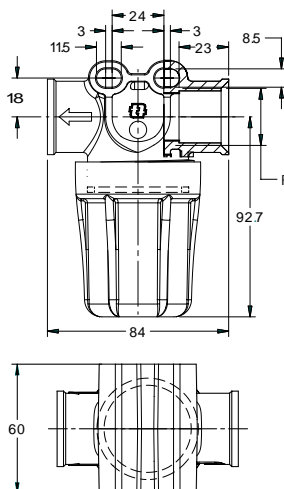

Part No.	F		Screen	Effective area		Pack
				cm <sup>2</sup>	Sq.in.	
<b>8105040</b>	G 3/4"	55	INOX 32 Mesh	25,6	4.0	10
<b>8105041</b>			INOX 50 Mesh	23,5	3.6	
<b>8105042</b>			INOX 80 Mesh	25,6	4.0	
<b>8105043</b>			INOX 100 Mesh	21,5	3.3	
<b>8105036</b>	G 1/2"	55	INOX 32 Mesh	25,6	4.0	10
<b>8105037</b>			INOX 50 Mesh	23,5	3.6	
<b>8105038</b>			INOX 80 Mesh	25,6	4.0	
<b>8105039</b>			INOX 100 Mesh	21,5	3.3	

Spare parts

	Part No.	Screen	Gasket
	<b>C00100057</b>	INOX 32 Mesh	G00002052
	<b>C00100058</b>	INOX 50 Mesh	
	<b>C00100059</b>	INOX 80 Mesh	
	<b>C00100060</b>	INOX 100 Mesh	



Filtri di mandata per pressioni di esercizio fino a 15 bar (220 PSI). Con filetti maschio.

Line filters for pressures up to 15 bar (220 PSI). With male threads.

Filtres en ligne pour pressions jusqu'à 15 bar (220 PSI). Avec filetage mâle.

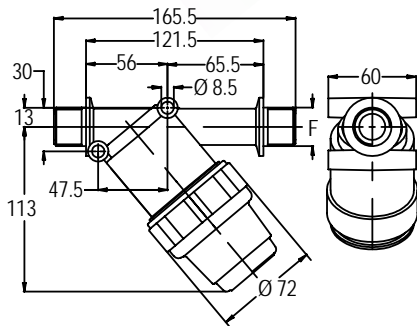

Part No.	F	I/I'	Screen	Effective area		Pack
				cm <sup>2</sup>	Sq.in.	
8118000	1/2"	80	INOX 32 Mesh	38	5,9	10
8118001			INOX 50 Mesh	35	5,4	
8118002			INOX 80 Mesh	32	5	
8118003			INOX 100 Mesh	34	5,3	
8118004	3/4"	100	INOX 32 Mesh	38	5,9	10
8118005			INOX 50 Mesh	35	5,4	
8118006			INOX 80 Mesh	32	5	
8118007			INOX 100 Mesh	34	5,3	
8118008	1"	150	INOX 32 Mesh	38	5,9	10
8118009			INOX 50 Mesh	35	5,4	
8118010			INOX 80 Mesh	32	5	
8118011			INOX 100 Mesh	34	5,3	

Spare parts

Part No.	Screen	Gasket
C00100005	INOX 50 Mesh	
C00100006	INOX 80 Mesh	
C00100007	INOX 100 Mesh	

Filtri di mandata per portate fino a 260 l/min. Con filetti maschio.

Line filters for flow rates up to 260 l/min (68 US GPM). With male threads.

Filtres en ligne pour debits jusqu'à 260 l/min. Avec filetage mâle.

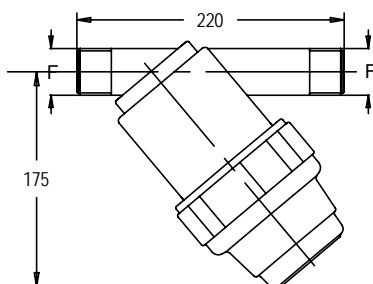

Part No.	F	bar	Pack
8118014	1 1/2"	8	5

Spare parts

Part No.	Screen
C00100062	PET 120 Mesh

- Filtri di aspirazione e mandata
- Suction and line filters
- Filtres d'aspiration et filtres en ligne

Filtri di mandata per portate fino a 600 l/min.  
Con filetti maschio.

Line filters for flow rates up to 600 l/min  
(16 0 US GPM). With male threads.

Filtres en ligne pour debits jusqu'à 600  
l/min. Avec filetage mâle.



**NEW**  
**NEW**

Part No.	F	Screen	⚡ bar	Pack
<b>8118017</b>	2"	INOX BAG 30 Mesh	8	5
<b>8118019</b>	2"	INOX BAG 50 Mesh	8	5
<b>8118013</b>	2"	POLY BAG 120 Mesh	8	5

Spare parts



Part No.	Screen	Gasket
<b>R00201059</b>	POLY BAG 120 Mesh	G00000025

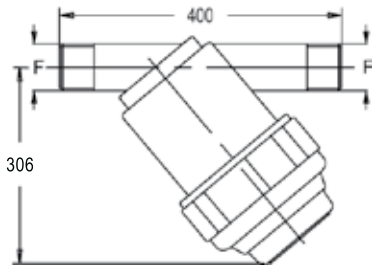

Filtri di mandata per portate fino a 800  
l/min. Con filetti maschio.

Line filters for flow rates up to 800 l/min  
(211 US GPM). With male threads.

Filtres en ligne pour debits jusqu'à 800  
l/min. Avec filetage mâle.



**NEW**  
**NEW**

Part No.	F	Screen	⚡ bar	Pack
<b>8118018</b>	3"	INOX BAG 30 Mesh	8	5
<b>8118020</b>	3"	INOX BAG 50 Mesh	8	5
<b>8118012</b>	3"	POLY BAG 120 Mesh	8	5

Spare parts



Part No.	Screen	Gasket
<b>R00201060</b>	POLY BAG 120 Mesh	G00000026

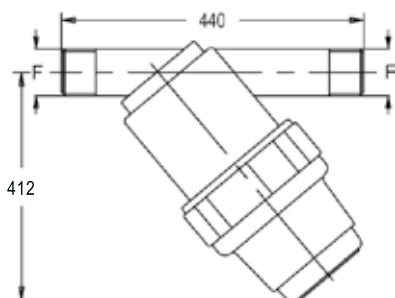

**Filtri galleggianti di aspirazione**

- Filtro galleggiante realizzato in materiale plastico antiurto.  
- Il raccordo girevole (da ordinare a parte) garantisce un perfetto galleggiamento del filtro anche con tubo di collegamento attorcigliato.

**Floating filters**

- Suction floating filter in shock-resistant plastic.  
- The swivel fitting (to be ordered separately) assures the perfect floating even in case of twisted pipe.

**Filtres flottants d'aspiration**

- Filtre flottant d'aspiration fabriqué en plastique antichoc.  
- Le raccord tournant (à commander séparément) assure le flottement parfait du filtre, même en cas de tuyau d'aspiration entortillé.

Part No.	F	Pack
R0000020	33	5
R0000021	35	
R0000022	40	
R0000023	50	



Part No.	Pack
8062003	5



**Cestini di fondo.**

**Foot filters.**

**Filtres de fond.**

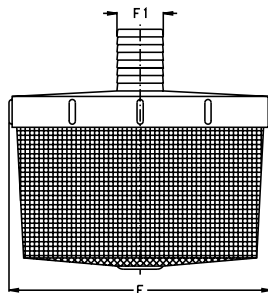

Part No.	F	F1	Type	Pack
8060000	100	15		25
8060001	100	20		25
8060002	137	20		25
8060003	137	25		25
8060004	137	30		10
8060005	137	30		10
8060006	137	35		10
8060007	137	40		10

**Filtri di aspirazione per detergente (con contrappeso).**

**Suction filters for detergents (with counterweight).**

**Filtres d'aspiration pour détergents (avec contrepoids).**

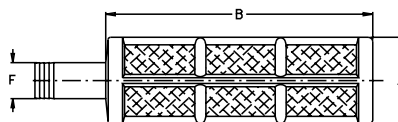

Part No.	F	A	B	Pack
8064000	8	22	40	10
* 8064001	8+VALV.	22	40	10

\* Fino ad esaurimento  
Selling out  
Jusqu'à épuisement

**Filtri di aspirazione**

**Suction filters**

**Filtres d'aspiration**

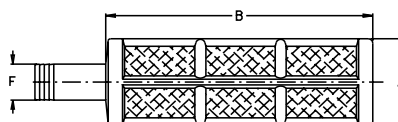

Part No.	F	A	B	Pack
8064002	19	42	65	10
8064003	25	42	65	10

- Filtri di aspirazione e mandata
- Suction and line filters
- Filtres d'aspiration et filtres en ligne

**Filtri in linea flangiati** con spurgo per gruppi di comando manuali ed elettrici serie PILOT.

**Flanged line filters** with drain valve for manual and electric control units PILOT.

**Filtres en ligne bridés** et avec vanne de nettoyage pour groupes de commande manuels et électriques PILOT.

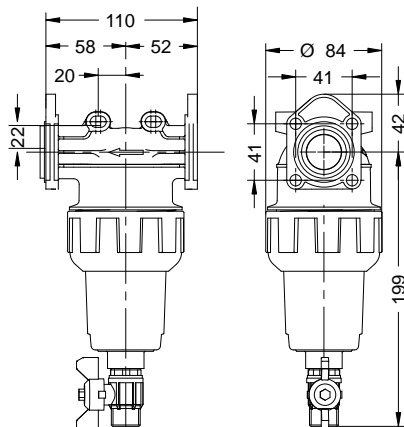

Part No.	Screen	bar	1/1"	Pack
8125007	INOX 32 Mesh	50	150	4
8125008	INOX 50 Mesh	50	150	4
8125009	INOX 80 Mesh	50	150	4

Spare parts

Part No.	Screen	Gasket
C00100004	INOX 32 Mesh	G00001024
C00100005	INOX 50 Mesh	
C00100006	INOX 80 Mesh	

**Filtri in linea attacco rapido** con spurgo per gruppi di comando manuali ed elettrici.

**Quick connection line filters** with drain valve for manual and electric control units.

**Filtres en ligne raccord rapide** avec vanne de nettoyage pour groupes de commande manuels et électriques.

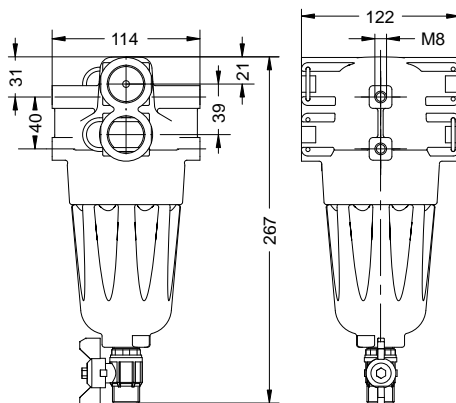

Part No.	Screen	bar	1/1"	Pack
8135004	INOX 32 Mesh	50	150	4
8135005	INOX 50 Mesh	50	150	4
8135006	INOX 80 Mesh	50	150	4

Spare parts

Part No.	Screen	Gasket
C00100014	INOX 32 Mesh	G00001040
C00100015	INOX 50 Mesh	
C00100016	INOX 80 Mesh	

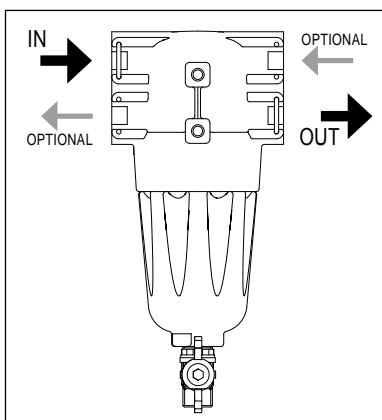

<table border="1"> <thead> <tr> <th>Part No.</th> <th>Ø mm</th> </tr> </thead> <tbody> <tr> <td>R00000014</td> <td>10</td> </tr> <tr> <td>R00000015</td> <td>13</td> </tr> <tr> <td>R00000016</td> <td>16</td> </tr> <tr> <td>R00000017</td> <td>19</td> </tr> </tbody> </table>	Part No.	Ø mm	R00000014	10	R00000015	13	R00000016	16	R00000017	19	<table border="1"> <thead> <tr> <th>Part No.</th> <th>Ø</th> </tr> </thead> <tbody> <tr> <td>R00000083</td> <td>G 3/4" M</td> </tr> <tr> <td>R00000066</td> <td>G 1/2" M *</td> </tr> </tbody> </table>	Part No.	Ø	R00000083	G 3/4" M	R00000066	G 1/2" M *	<table border="1"> <thead> <tr> <th>Part No.</th> </tr> </thead> <tbody> <tr> <td>T00000018</td> </tr> <tr> <td>T00000034 *</td> </tr> </tbody> </table>	Part No.	T00000018	T00000034 *
Part No.	Ø mm																				
R00000014	10																				
R00000015	13																				
R00000016	16																				
R00000017	19																				
Part No.	Ø																				
R00000083	G 3/4" M																				
R00000066	G 1/2" M *																				
Part No.																					
T00000018																					
T00000034 *																					
<table border="1"> <thead> <tr> <th>Part No.</th> <th>Ø mm</th> </tr> </thead> <tbody> <tr> <td>R00000082</td> <td>13</td> </tr> </tbody> </table>	Part No.	Ø mm	R00000082	13	<table border="1"> <thead> <tr> <th>Part No.</th> <th>Ø</th> </tr> </thead> <tbody> <tr> <td>R00000084</td> <td>G 3/4" F</td> </tr> <tr> <td>R00000085</td> <td>NPT 3/4" F</td> </tr> </tbody> </table>	Part No.	Ø	R00000084	G 3/4" F	R00000085	NPT 3/4" F										
Part No.	Ø mm																				
R00000082	13																				
Part No.	Ø																				
R00000084	G 3/4" F																				
R00000085	NPT 3/4" F																				

**\* = Ottone / Brass / Laiton**

Filtri di mandata per portate fino a 150 l/min e pressioni fino a 50 bar.

Line filters for flow rates up to 150 l/min (40 US GPM) and pressure up to 50 bar (720 PSI).

Filtres en ligne pour débits jusqu'à 150 l/min et pressions jusqu'à 50 bar.



Part No.	F	Screen	Effective area		Pack
			cm <sup>2</sup>	Sq.in.	
<b>8135000</b>		INOX 32 Mesh	70	10,9	
<b>8135001</b>	3/4"	INOX 50 Mesh	64	10	4
<b>8135002</b>		INOX 80 Mesh	59	9,1	

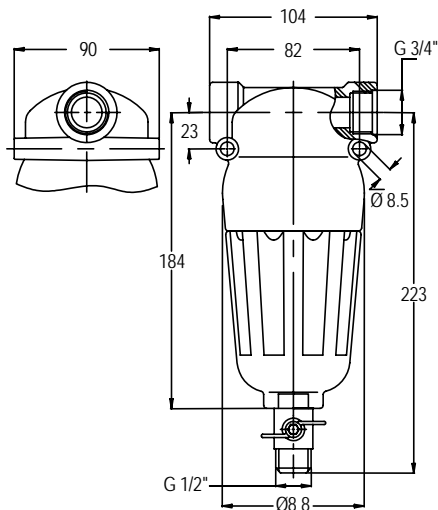

Spare parts

Part No.	Screen	Gasket
<b>C00100015</b>	INOX 50 Mesh	G00001032
<b>C00100016</b>	INOX 80 Mesh	

Tappo in ottone.

Brass plug.

Bouchon en laiton.

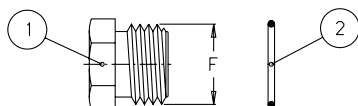

Part No. 1	Part No. 2	F	Pack
<b>8304000</b>	<b>G00001058</b>	G 3/4"	10

Nipplo in ottone.

Brass nipple.

Adaptateur en laiton.

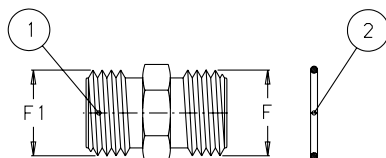

Part No. 1	Part No. 2	F	F1	Pack
<b>8304001</b>	<b>G00001058</b>	G 3/4"	G 1/2"	10
<b>8304002</b>	<b>G00001058</b>	G 3/4"	G 3/4"	10

- Filtri di aspirazione e mandata
- Suction and line filters
- Filtres d'aspiration et filtres en ligne

Filtri di mandata in ottone per portate fino a 70 l/min e pressioni fino a 50 bar.

Brass line filters for flow rates up to 70 l/min (18.5 US GPM) and pressure up to 50 bar (720 PSI).

Filtres en ligne en laiton pour débits jusqu'à 70 l/min et pressions jusqu'à 50 bar.

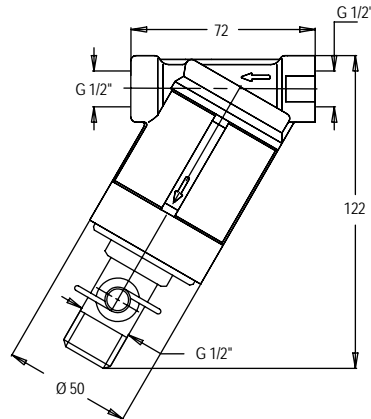

Part No.	F	Screen	Pack
<b>8137009</b>		INOX 30 Mesh	
<b>8137008</b>	1/2"	INOX 40 Mesh	5
<b>8137010</b>		INOX 70 Mesh	

Spare parts

	Part No.	Screen
	C00100051	INOX 30 Mesh
	C00100042	INOX 40 Mesh
	C00100052	INOX 70 Mesh

Filtri di mandata in ottone per portate fino a 70 l/min e pressioni fino a 50 bar.

Brass line filters for flow rates up to 70 l/min (18.5 US GPM) and pressure up to 50 bar (720 PSI).

Filtres en ligne en laiton pour débits jusqu'à 70 l/min et pressions jusqu'à 50 bar.

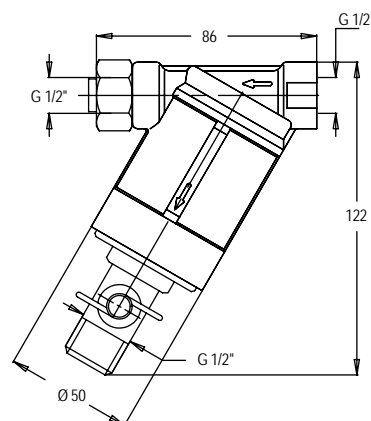

Part No.	F	Screen	Pack
<b>8137011</b>		INOX 30 Mesh	
<b>8137004</b>	1/2"	INOX 40 Mesh	5
<b>8137012</b>		INOX 70 Mesh	

Spare parts

	Part No.	Screen
	C00100051	INOX 30 Mesh
	C00100042	INOX 40 Mesh
	C00100052	INOX 70 Mesh



Filtri di mandata in ottone per portate fino a 150 l/min e pressioni fino a 50 bar.

Brass line filters for flow rates up to 150 l/min (40 US GPM) and pressure up to 50 bar (720 PSI).

Filtres en ligne en laiton pour débits jusqu'à 150 l/min et pressions jusqu'à 50 bar.

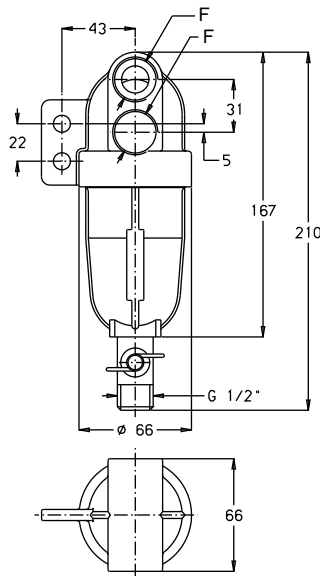

Part No.	F	Screen	Effective area cm <sup>2</sup>	Sq.in.	Pack
<b>8137006</b>		INOX 30 Mesh			
<b>8137007</b>	G 3/4"	INOX 40 Mesh	145	22	
<b>NEW 8137015</b>		INOX 80 Mesh			
<b>NEW 8137016</b>		INOX 100 Mesh			4
<b>8137013</b>		INOX 30 Mesh			
<b>8137014</b>	G 1/2"	INOX 40 Mesh	145	22	
<b>NEW 8137017</b>		INOX 80 Mesh			
<b>NEW 8137018</b>		INOX 100 Mesh			

Spare parts



Part No.	Screen
C00100043	INOX 30 Mesh
C00100044	INOX 40 Mesh
C00100053	INOX 80 Mesh
C00100054	INOX 100 Mesh

Filtro a siluro per portate fino a 110 l/min e pressioni fino a 50 bar.

"Torpedo" filter for flow rates up to 110 l/min (29 US GPM), max. pressure 50 bar (720 PSI).

Filtre à "torpille" pour débit jusqu'à 110 l/min et pressions jusqu'à 50 bar.



Part No.	F	Screen	Pack
<b>8137005</b>		INOX 40 Mesh	4

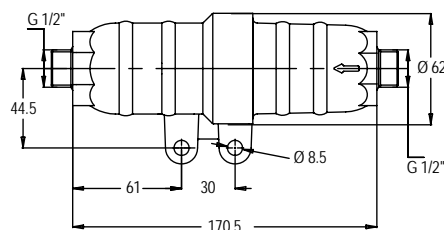

Spare parts



Part No.	Screen
C00100041	INOX 40 Mesh