



Precision Tooling
ITALY

Cylinder assy - Piston assy	54
Piston rings	57
Crankshafts	58
Vibration dampings	58
Air filters	59
Fuel Filters	63
Fuel Caps	64
Oil Caps	64
Starter rope	64
Pulleys	65
Pawls	65
Metal rings - Plastic rings	65
Gasket sets	66
Sprocket covers	66
Exhausts	66
Starter handles	67
Spark plugs	68
Chain tighteners	69
Tube handles	69
Nuts	69
Ignition coils	70
Spark plug terminals	70
Insulated cable	70
Switches	71
Wrenches	71



Packaging & Shipment

Type of packaging

	Carton box
	Plastic clamshell / Blister
	Nylon bag

Type of shipment and minimum q.ty per order

	Carton master shipper
---	-----------------------

Suitable for the following chain saws:

Cylinder assy - Piston assy



MAKE FITS	DESCRIPTION	P/N	O.E.M. Ref
HUSQVARNA 254-254XP	Cylinder assy ø 45 mm	88570264	503 50 39-02
	Piston assy	88572507	503 50 37-01

STANDARD PACKAGING:

1 SET PER BOX



MAKE FITS	DESCRIPTION	P/N	O.E.M. Ref
HUSQVARNA 61	Cylinder assy ø 48 mm	88570252	503 53 20-71
	Piston assy	88572499	503 53 90-02

STANDARD PACKAGING:

1 SET PER BOX



MAKE FITS	DESCRIPTION	P/N	O.E.M. Ref
HUSQVARNA 268-268S-268K	Cylinder assy ø 50 mm	88570280	501 65 85-71
	Piston assy	88572524	501 65 94-03

STANDARD PACKAGING:

1 SET PER BOX



MAKE FITS	DESCRIPTION	P/N	O.E.M. Ref
HUSQVARNA 65-265	Cylinder assy ø 48 mm	88570282	50 14 178-01
	Piston assy	88572526	50 12 056-03

STANDARD PACKAGING:

1 SET PER BOX



Suitable for the following chain saws:

Cylinder assy - Piston assy



MAKE FITS	DESCRIPTION	P/N	O.E.M. Ref
PARTNER K650 ACTIVE	Cylinder assy ø 50 mm	88570268	506 09 92-12
	Piston assy	88572511	506 09 90-01
	De-Compression Valve	88576118	503 71 53-01

STANDARD PACKAGING: 1 SET PER BOX



MAKE FITS	DESCRIPTION	P/N	O.E.M. Ref
STIHL 026	Cylinder assy ø 44 mm	88570281	1121 020 1208
	Piston assy	88572525	1121 030 2001

STANDARD PACKAGING: 1 SET PER BOX



MAKE FITS	DESCRIPTION	P/N	O.E.M. Ref
STIHL 028 SUPER	Cylinder assy ø 46 mm	88570216	1118 020 1202
	Piston assy	88572449	1118 030 2003

STANDARD PACKAGING: 1 SET PER BOX



MAKE FITS	DESCRIPTION	P/N	O.E.M. Ref
STIHL 034-036	Cylinder assy ø 48 mm	88570250	1125 020 1213
	Piston assy	88572497	1125 030 2001

STANDARD PACKAGING: 1 SET PER BOX



Suitable for the following chain saws:

Cylinder assy - Piston assy



MAKE FITS	DESCRIPTION	P/N	O.E.M. Ref
STIHL	Cylinder assy ø 52 mm	88570272	1119 020 1202
038 MAGNUM	Piston assy	88572515	1119 030 2002

STANDARD PACKAGING:

1 SET PER BOX



MAKE FITS	DESCRIPTION	P/N	O.E.M. Ref
STIHL	Cylinder assy ø 52 mm	88570162	1111 020 1200
051-TS510	Piston assy	88572261	1111 030 2000

STANDARD PACKAGING:

1 SET PER BOX



MAKE FITS	DESCRIPTION	P/N	O.E.M. Ref
STIHL	Cylinder assy ø 47 mm	88570155	1108 020 1220
08-TS350	Piston assy	88572247	1108 030 2020

STANDARD PACKAGING:

1 SET PER BOX



MAKE FITS	DESCRIPTION	P/N	O.E.M. Ref
STIHL	Cylinder assy ø 49 mm	88570227	4201 020 1200
08S-TS360	Piston assy	88572460	4201 030 2000

STANDARD PACKAGING:

1 SET PER BOX



Cylinder assy - Piston assy

Suitable for the following chain saws:



MAKE FITS	DESCRIPTION	P/N	O.E.M. Ref
STIHL	Cylinder assy ø 49 mm	88570277	4223 020 1200
TS400	Piston assy	88572521	4223 030 2000

STANDARD PACKAGING:

1 SET PER BOX



Piston rings

Suitable for the following chain saws:



MAKE	FITS	Ø mm	P/N	O.E.M. Ref
DOLMAR	123-309	47	574119	123 132 020
HUSQVARNA	242-242XP	42	574159	503 28 90-05
	254-254XP	45	574161	503 28 90-11
	61	48	574157	503 28 90-15
	266-266XP	50	574142	501 69 98-01
	268-268S-268K	50	574142	503 28 90-17
	65-265	48	574157	5012 059-02
PARTNER	K650 ACTIVE	50	574137	503 28 90-17
STIHL	026	44	574170	1121 034 3010
	028 SUPER	46	574144	1118 034 3001
	034-036	48	574158	1125 034 3001
	038 MAGNUM	52	574106	1115 034 3010
	051-TS510	52	574106	1115 034 3001
	08S-TS350	47	574119	1108 034 3001
	TS360	49	574143	4201 034 3000
TS400	49	574143	1127 034 3003	

STANDARD PACKAGING: 10 PCS. PER CLAMSHELL



ORDER IN MULTIPLES OF (10)

Crankshafts

Suitable for the following chain saws:



MAKE FITS	DESCRIPTION	P/N	O.E.M. Ref
DOLMAR	123-309	88590143	123 120 002
HUSQVARNA	61-268-272(AFTER 93)	88590165	503 61 3371
PARTNER	K650 ACTIVE (New)	88590200	503 15 80-01
STIHL	051-075	88590119	1111 030 0402
	038-038 SUPER 038 MAGNUM	88590150	1119 030 0400
	08-08S-TS350-TS360	88590116	1108 030 042
	TS400	88590156	4223 030 0400

STANDARD PACKAGING:

1 PC. PER BOX



ORDER IN MULTIPLES OF (10)

Vibration dampings

Suitable for the following chain saws:



MAKE FITS	DESCRIPTION	P/N	O.E.M. Ref
HUSQVARNA	480-61-162 Metal Crankcase	657122	50 12 763-01
	61-162 Metal Crankcase	657123	50 15 305-01
	266 Plastic Crankcase	657132	501 69 94-01
	266 Plastic Crankcase	657133	501 62 87-01
STIHL	028-038 Series	657134	1118 790 9930
	038 Series	657135	1121 790 9912
	028-038 Series	657136	1121 790 9909
	051 AV Back Handle	657140	1111 790 9900
	051 AV Back Handle (Down)	657141	1111 790 9915
	051 AV Front Handle (Up)	657142	1111 790 9905

STANDARD PACKAGING:

10 PCS. PER NYLON BAG



ORDER IN MULTIPLES OF (10)

Air filters

Suitable for the following chain saws:

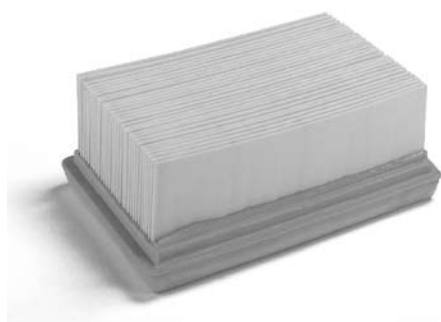

DOLMAR

OUR REF.

PC 62 12-PC 62 14

540355

O.E.M. part No. 394 173/010

STANDARD PACKAGING: 5 PCS. PER NYLON BAG



ORDER IN MULTIPLES OF (5)



HUSQVARNA

OUR REF.

61-66-266-281-288

540173

O.E.M. part No. 501 80 71 01

STANDARD PACKAGING: 5 PCS. PER NYLON BAG



ORDER IN MULTIPLES OF (5)



PARTNER

OUR REF.

R16-S50-S55-P55-P70

540127

O.E.M. part No. 315475

STANDARD PACKAGING: 5 PCS. PER NYLON BAG



ORDER IN MULTIPLES OF (5)



PARTNER

OUR REF.

K650 (Pre-filter)

540273

O.E.M. part No. 505 315 545

STANDARD PACKAGING: 5 PCS. PER NYLON BAG



ORDER IN MULTIPLES OF (5)

Air filters

Suitable for the following chain saws:



PARTNER	OUR REF.
K650 ACTIVE	540338
O.E.M. part No. 506 22 42-01	
STANDARD PACKAGING:	5 PCS. PER NYLON BAG 
ORDER IN MULTIPLES OF (5)	



STIHL	OUR REF.
028	540166
O.E.M. part No. 1118 120 1610	
STANDARD PACKAGING:	5 PCS. PER NYLON BAG 
ORDER IN MULTIPLES OF (5)	



STIHL	OUR REF.
038	540172
O.E.M. part No. 1119 120 1610	
STANDARD PACKAGING:	5 PCS. PER NYLON BAG 
ORDER IN MULTIPLES OF (5)	



STIHL	OUR REF.
051	540136
O.E.M. part No. 1111 120 1601	
STANDARD PACKAGING:	5 PCS. PER NYLON BAG 
ORDER IN MULTIPLES OF (5)	

Air filters

Suitable for the following chain saws:



STIHL	OUR REF.
08	540134
O.E.M. part No. 1108 120 1600	
STANDARD PACKAGING:	5 PCS. PER NYLON BAG 
ORDER IN MULTIPLES OF (5)	



STIHL	OUR REF.
TS 350-510	540133
O.E.M. part No. 4201 140 1801	
STANDARD PACKAGING:	5 PCS. PER NYLON BAG 
ORDER IN MULTIPLES OF (5)	



STIHL	OUR REF.
TS 360	540174
O.E.M. part No. 4201 140 1802	
STANDARD PACKAGING:	5 PCS. PER NYLON BAG 
ORDER IN MULTIPLES OF (5)	



STIHL	OUR REF.
TS 350-360-510 (Pre filter)	540238
O.E.M. part No. 4201 141 0310	
STANDARD PACKAGING:	5 PCS. PER NYLON BAG 
ORDER IN MULTIPLES OF (5)	

Air filters

Suitable for the following chain saws:



STIHL	OUR REF.
TS 350-360-510 (Outer)	540171
O.E.M. part No. 4201 141 0300	
STANDARD PACKAGING: 5 PCS. PER NYLON BAG	
ORDER IN MULTIPLES OF (5)	



STIHL	OUR REF.
TS 400	540332
O.E.M. part No. 4223 140 0300	
STANDARD PACKAGING: 5 PCS. PER NYLON BAG	
ORDER IN MULTIPLES OF (5)	

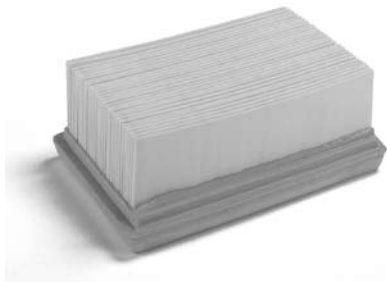

STIHL	OUR REF.
TS 400	540336
O.E.M. part No. 4223 141 0300	
STANDARD PACKAGING: 5 PCS. PER NYLON BAG	
ORDER IN MULTIPLES OF (5)	



STIHL	OUR REF.
TS 400	540337
O.E.M. part No. 4223 141 0600	
STANDARD PACKAGING: 5 PCS. PER NYLON BAG	
ORDER IN MULTIPLES OF (5)	

Suitable for the following chain saws:

Air filters



FUEL FILTER "POREX" (HU Type) OUR REF.

Small "POREX" **524103**

POREX **524104**

STANDARD PACKAGING: 10 PCS. PER NYLON BAG



ORDER IN MULTIPLES OF (10)



FUEL FILTER ASSY (HU Type) OUR REF.

Small FELT **524901**

FELT Only **524900**

STANDARD PACKAGING: 10 PCS. PER NYLON BAG



ORDER IN MULTIPLES OF (10)



FUEL FILTER ASSY (HS Type) OUR REF.

Large FELT **524101**

FELT Only **524102**

STANDARD PACKAGING: 10 PCS. PER NYLON BAG



ORDER IN MULTIPLES OF (10)



SUPER TYPE with inside sintered element OUR REF.

FUEL FILTER ASSY (standard fitting) **524123**

FUEL FILTER ASSY (suitable for Stihl) **524133**

STANDARD PACKAGING: 10 PCS. PER NYLON BAG



ORDER IN MULTIPLES OF (10)



FUEL FILTERS "POREX" OUR REF.

ø 5 mm (suitable for HUSQVARNA) **524148**

ø 5,7 mm (suitable for TILLOTSON) **524154**

ø 8,5 mm (suitable for STIHL) **524155**

STANDARD PACKAGING: 10 PCS. PER NYLON BAG



ORDER IN MULTIPLES OF (10)



RUBBER FUEL LINE OUR REF.

ø i 3,2 mm **524106**

ø i 4,5 mm **524107**

STANDARD PACKAGING: 5 m PER NYLON BAG



5 m per reel - the price is per 1 m

Fuel Caps

Suitable for the following chain saws:

MAKE FITS	DESCRIPTION	P/N	O.E.M. Ref
HUSQVARNA	36-41-42-50-55-154-254 262-281-288-394-3120	550151	501 81 96 02
	234-238	550151	501 81 96-01
	65-77 (New)-380-480	551107	501 56 45-01
	61-66-266-268-272-2101	551107	501 43 14 02
	181	550151	501 81 96-01
JONSERED	625-630-631-670	551107	5015 645-01
STIHL	044	550145	1117 350 0500
	024-028-034-038-042-048	550145	1117 350 0500
	08	550121	1107 350 0500

STANDARD PACKAGING: 10 PCS. PER NYLON BAG



ORDER IN MULTIPLES OF (10)

Oil Caps

Suitable for the following chain saws:

MAKE FITS	DESCRIPTION	P/N	O.E.M. Ref
HUSQVARNA	36-41-42-50-55-154-254-262	551153	501 76 56 02
	234-238	551145	501 62 66-01
	281-288-394	550151	501 81 96 02
	42-61-66-242-266-268-272	551145	501 62 66 02
	181	550151	501 81 96-01
STIHL	044	550145	1117 350 0500
	024-028-034-038-042-048	551149	1117 640 3600
	064-084	550145	1117 350 0500
	032	551149	1117 640 3600

STANDARD PACKAGING: 10 PCS. PER NYLON BAG



ORDER IN MULTIPLES OF (10)

Starter rope

Suitable for the following chain saws:



DESCRIPTION	P/N
Spool Ø 3 x 100 m	560125
Spool Ø 3,5 x 100 m	560126
Spool Ø 4 x 100 m	560127
Spool Ø 4,5 x 100 m	560128

The price is per 100 m spool

Pulleys

Suitable for the following chain saws:



MAKE FITS	DESCRIPTION	P/N	O.E.M. Ref
HUSQVARNA	266-66-181 (Bore ø 10)	560182	501 52 07-01
	266-66-181 (Bore ø 14)	560211	503 10 24-02
	268-272 (Bore ø 14 Hub Long)	560253	503 10 24 03
STIHL	036-044	560237	1128 195 0400
	08	560146	1107 190 1000
	038-041-042-045-048-051-056	560224	1117 195 0402
	08-075-TS350 (Metal)	560201	1125 195 0401
	034-024 (Nylon)		
08-051-064-066 (Nylon)	560200	1122 195 0400	

STANDARD PACKAGING: 5 PCS. PER NYLON BAG



ORDER IN MULTIPLES OF (5)

Pawls

Suitable for the following chain saws:



MAKE FITS	DESCRIPTION	P/N	O.E.M. Ref
STIHL	009-010-011-024 028 (Old Model)-032	560111	1118 195 7200
	08-038-042-048-051-056 (Old Mod)	560170	1117 195 7200
	Pawl Spring	560179	1117 195 3500
	08-038-051-056-064-066-076- 084-TS360	560202	1124 195 7200
	009-010-011-012-021-023-024-025- 026-028-034-036-044	560203	1125 195 7200

STANDARD PACKAGING: 10 PCS. PER NYLON BAG



ORDER IN MULTIPLES OF (10)

Metal rings - Plastic rings

Suitable for the following chain saws:



MAKE FITS	MODEL	DESCRIPTION	P/N	O.E.M. Ref
STIHL	08-041-045	Metal ring	560115	0000 961 5115
	050-051	Metal ring	560117	1111 195 4100
	08-041-045	Plastic ring	560116	0000 961 5116

STANDARD PACKAGING: 10 PCS. PER NYLON BAG



ORDER IN MULTIPLES OF (10)

Gasket sets

Suitable for the following chain saws:



MAKE FITS	DESCRIPTION	P/N
HUSQVARNA	61-162-266-268	640145A
PARTNER	K650 ACTIVE	640182
STIHL	034-036	640158A
	08-TS350	640131A
	051	640136A
	024-026	640180A
	TS400	640181A

STANDARD PACKAGING: SKINPACK - 1 SET



Sprocket covers

Suitable for the following chain saws:



MAKE FITS	DESCRIPTION	P/N	O.E.M. Ref
STIHL	08 (complete of tank cover)	650124	1108 640 1705

STANDARD PACKAGING: 1 PC PER NYLON BAG



Exhausts

Suitable for the following chain saws:



MAKE FITS	MODEL	P/N	O.E.M. Ref
HUSQVARNA	266	610140	501 65 76-01
STIHL	038-038S	610139	1119 140 0600

STANDARD PACKAGING: 1 PC PER NYLON BAG



Starter handles

Suitable for the following chain saws:



STIHL	OUR REF.
010-015-020-028-031-032 (Old Mod.)	560119
STANDARD PACKAGING: 10 PCS. PER NYLON BAG	
ORDER IN MULTIPLES OF (10)	



STIHL	OUR REF.
08-038-041-042-048-051-056-070-075 (Old Mod.)	560118
STANDARD PACKAGING: 10 PCS. PER NYLON BAG	
ORDER IN MULTIPLES OF (10)	



STIHL	OUR REF.
Standard (New)	560213
STANDARD PACKAGING: 10 PCS. PER NYLON BAG	
ORDER IN MULTIPLES OF (10)	



HUSQVARNA	OUR REF.
Standard O.E.M. part No. 501 55 14-02	560191
STANDARD PACKAGING: 10 PCS. PER NYLON BAG	
ORDER IN MULTIPLES OF (10)	

Suitable for the following chain saws:

Starter handles



STANDARD TYPE-SMALL

OUR REF.

560121

STANDARD PACKAGING: 10 PCS. PER NYLON BAG



ORDER IN MULTIPLES OF (10)



STANDARD TYPE-MEDIUM

OUR REF.

560120

STANDARD PACKAGING: 10 PCS. PER NYLON BAG



ORDER IN MULTIPLES OF (10)



STANDARD TYPE-LARGE COMPLETE WITH PLASTIC CAP

OUR REF.

560123

STANDARD PACKAGING: 10 PCS. PER NYLON BAG



ORDER IN MULTIPLES OF (10)



ROPE METAL STOP

OUR REF.

560122

STANDARD PACKAGING: 10 PCS. PER NYLON BAG



ORDER IN MULTIPLES OF (10)

Spark plugs

Suitable for the following chain saws:



ENGINE	OUR REF.	HEXAGON	SUITABLE FOR		
			BOSCH	CHAMPION	NKG
CHAIN SAW	88501159	19	WS7E	CJ8	BM6A
CHAIN SAW	88501157	19	WS7F	CJ7Y	BPM7A

CHAIN SAW **88501159**

19

WS7E

CJ8

BM6A

CHAIN SAW **88501157**

19

WS7F

CJ7Y

BPM7A

STANDARD PACKAGING: 10 PCS. PER BOX



ORDER IN MULTIPLES OF (10)

Chain tighteners

Suitable for the following chain saws:



MAKE FITS	DESCRIPTION	P/N	O.E.M. Ref
HUSQVARNA	51-61-66-162-181-266-268 272-281-288	651172	501 53 71 01
	42-44-50-51-55 238-242-444	651173	501 81 92 01
	154-254-262	651192	501 53 71 01
JONSERED	629-630-670	651172	1118 664 1600
STIHL	028-038	651152	1110 664 1500 1110 664 1600
	031-032-041-042-045 048-056	651155	1110 664 1500 0000 951 2911
	08-051-075	651157	1106 644 1500

STANDARD PACKAGING: 10 PCS. PER NYLON BAG



ORDER IN MULTIPLES OF (10)

Tube handles

Suitable for the following chain saws:



MAKE FITS	DESCRIPTION	P/N	O.E.M. Ref
HUSQVARNA	61-66-266-268-272	654138	501 53 45-03
	50 SPECIAL-51-55-254	654151	501 87 29 07

STANDARD PACKAGING: 1 PC. PER NYLON BAG



Nuts

Suitable for the following chain saws:



MAKE FITS	DESCRIPTION	P/N		
		BAR	SPROCKET	FLYWHEEL
STIHL	010-015-031-032-041	670101		
	028 (Old)-020	670101		
	042-045	670101		672110
	050-051-075	670113		
	056	670101	671102	672110
	08	670113		672110
	024-028-038-044	670114		

STANDARD PACKAGING: 10 PCS. PER NYLON BAG



ORDER IN MULTIPLES OF (10)

Ignition coils

Suitable for the following chain saws:



ENGINE	DESCRIPTION	OUR REF.	
		TECOMEC	DUCATI
HUSQVARNA	45-51-55-61-254-257-262 268-272-394-Brusch cutter 250RT-250R-245R240R	502185*	
STIHL	021-023		502169*
	041-045		502901
	038 MAGNUM	502183*	
	051	502184*	
		* ELECTRONIC IGNITION	

STANDARD PACKAGING: 1 PC. PER NYLON BAG



Spark plug terminals

Suitable for the following chain saws:



SPARK PLUG TERMINAL WITH SPRING	OUR REF.
5 mm wire	506102
7 mm wire	506101
Spring only	506103

STANDARD PACKAGING: 10 PCS. PER NYLON BAG



ORDER IN MULTIPLES OF (10)



SPARK PLUG TERMINAL	OUR REF.
Standard type	506107

STANDARD PACKAGING: 10 PCS. PER NYLON BAG



ORDER IN MULTIPLES OF (10)

Insulated cable

Suitable for the following chain saws:



RUBBER INSULATED CABLE for high temperatures from -20°++100°C	OUR REF.
ø 5 mm x 10 m	506142
ø 7 mm x 10 m	506143

STANDARD PACKAGING: 10 m PER NYLON BAG



The price is per 1 m

RUBBER INSULATED CABLE STANDARD	OUR REF.
ø 5 mm x 10 m	506111
ø 7 mm x 10 m	506112

STANDARD PACKAGING: 10 m PER NYLON BAG



The price is per 1 m

Switches

Suitable for the following chain saws:



SWITCH	OUR REF.
Universal type	506110
HUSQVARNA 61-266-281-288 (O.E.M. Part No. 501 52 66 02)	506163
STANDARD PACKAGING: 10 PCS. PER NYLON BAG	
ORDER IN MULTIPLES OF (10)	

Wrenches

Suitable for the following chain saws:

MAKE	MODEL	DIMENSIONS (mm)					OUR REF.
		A	B	C	BAR	Plung	
ALPINA	A40-C40-CP45-A70-C70	150	52	33	13	19	2304023
DOLMAR	CA-CC-CT	172	35	35	17	21	2304014
	122-123-144-152-153-133-166-309-310-311	180	34	34	17	19	2304084
	112-113-114-116-117-119-120-120 Super	145	25	25	13	19	2304080
ECO	CS60-100-452-500-601-605-650-701-750-801-802	150	52	33	13	19	2304023
	280-302-304-315-351-400	150	60	30	10	19	2304077
HOMELITE	XL Series (1° Mod.)-925	150	55	25	16	19	2304020
	Mini	150	45	25	13	16	2304017
	XL Super VI-XL2	145	90	25	11	16	2304027
HUSQVARNA	65-77 (2° Mod.) 140-160-162-480-285-2100	150	52	33	13	19	2304023
	Husky	135	42	23	11	19	2304025
	61-154-181-234-266-44-444	145	25	25	13	19	2304080
JONSERED	625-630-670	127	22	21	13	19	2304080
MC CULLOCH	Standard	150	45	25	13	16	2304017
	Mac 6	145	90	25	11	16	2304027
OLEO MAC	E140-E160-233-240-935X-935DX	150	60	30	10	19	2304077
	254-350-355-945-950-938-941-942-946-951-970-980	150	52	33	13	19	2304023
	271-272-481-482-999	180	34	34	17	19	2304084
PARTNER	330-340	135	42	23	11	19	2304025
	R16-S50-S55-P55-P70-P100	150	52	33	13	19	2304023
PIONEER	P12	135	42	23	11	19	2304025
	P20-P21-P25-P26-P28-P40-P50-1200-1074-C55	150	52	33	13	19	2304023
	P41-P51 Farmsaw-P60	180	34	34	17	19	2304084
POULAN	200-300-400	160	54	24	14	19	2304024
QUADRA	Frontier	135	42	23	11	19	2304025
SOLO	50-70-125	172	35	35	17	21	2304014
	610-620-640-650	150	52	33	13	19	2304023
STIHL	010-015-020-028-031-032-041	170	50	18	13	19	2304010
	010-015-020-028-031-032-041	170	21	34	13	19	2304008
	045-050-051-075	180	34	34	17	19	2304084
	08	172	35	35	17	21	2304014
	Standard-New	175	35	15		19	2304068

STANDARD PACKAGING: 100 PCS. PER BOX

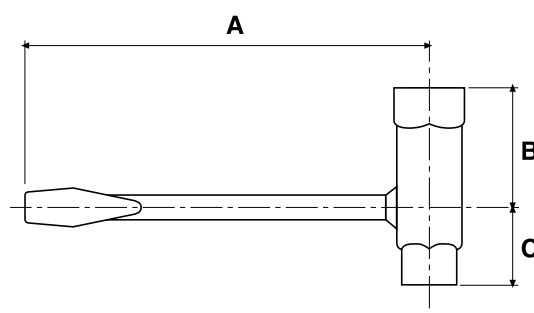

Wrenches

Suitable for the following chain saws:

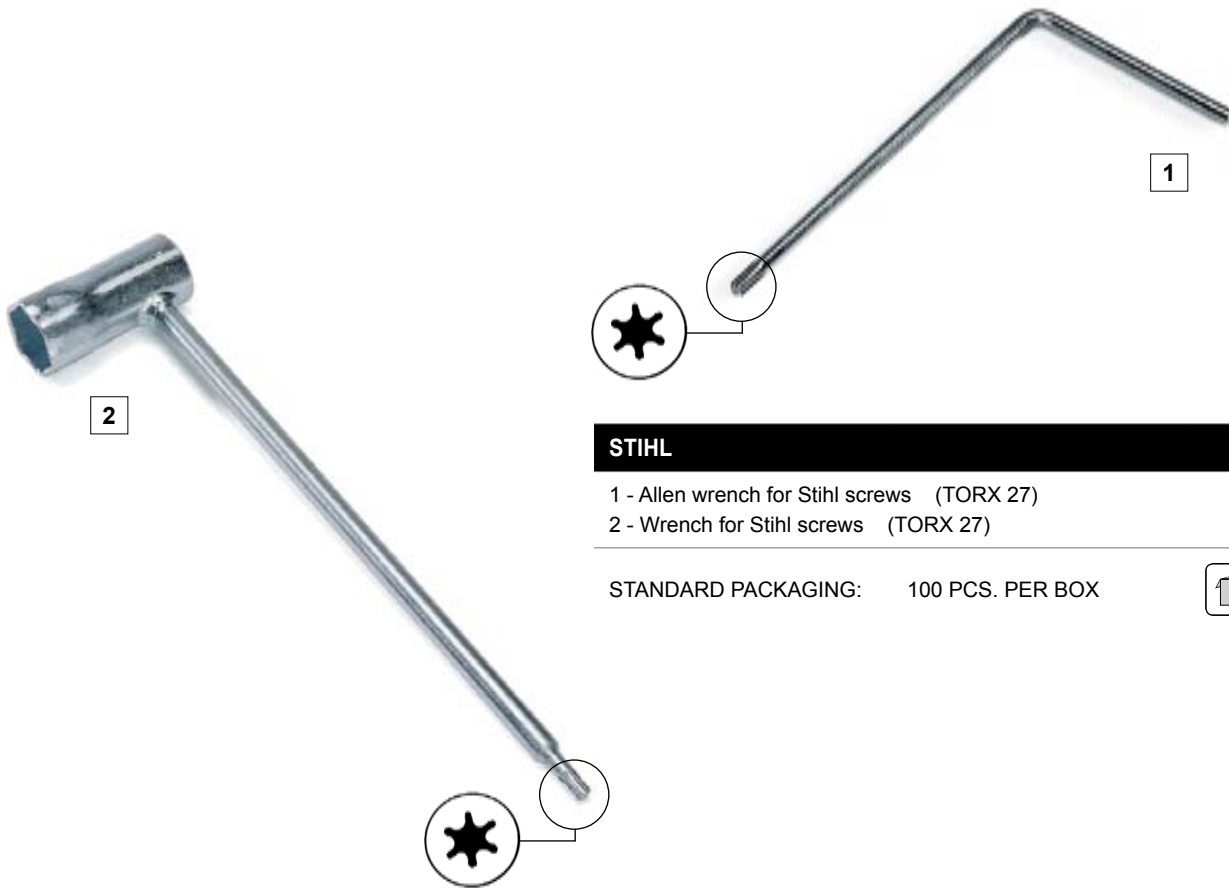

STIHL

OUR REF.

- 1 - Allen wrench for Stihl screws (TORX 27)
- 2 - Wrench for Stihl screws (TORX 27)

2304074
2304072

STANDARD PACKAGING: 100 PCS. PER BOX



ASPERA

OUR REF.

- 21 x 19 x \varnothing 11 Square-Aspera and Tecumsen

2304083

STANDARD PACKAGING: 100 PCS. PER BOX



BRIGGS & STRATTON

OUR REF.

- 24 x 19 x \varnothing 11 Square-Briggs & Stratton (box 60 pcs)
- 21 x 19 x \varnothing 3/8 Square-Briggs & Stratton Sprint

2304082
2304076

STANDARD PACKAGING: 100 PCS. PER BOX

